

Useless Box

GM3 Hinge Edition



Skill level: **Ages 12+**



Tools required
(not included)



2AA batteries required
(not included)



Build time: 1.5hours

Want to make something Useless?

It's not quite *totally* useless, especially if you like flipping switches. This machine will happily fix your attempts to turn it on. See the feature videos and articles at Youtube.com and Makezine.com.



www.solarbotics.com
1-866-276-2687

TOOLS:

Assembly is quite straightforward, but you'll still need:

- Soldering equipment (**do not** use conductive glue or solder paste)
- Wire cutters/strippers
- Philips #1 screwdriver
- Tape to assist with construction

WHAT THE HECK IS THIS?!

Good question.

It is an illustration of the pointlessness of man's existence. A demonstration of the classic Greek sisyphean task (yes, we looked it up. Neat story; check it out). The ultimate in self-defeat.

In short, you turn it on; it turns itself off. The ultimate in lazy, where the only energy expended is spent in making it as power-efficient as possible (ie: OFF!). No matter how you try to wake it, it does the equivalent of trying to crawl back into bed (perhaps it should be called the "Teenager-in-a-Box"?).

This circuit uses clever logic wiring to create this effect, which has roots waaay back in relay logic circuits. We're using a limit and "double-pole, double-throw" switch. These two switches route to the motor in a way that... well, make it want to turn itself off!

Yes, your significant-other may think this is a peculiar waste of time, but we'll bet the attraction to the switch will be irresistible. Our experiments have shown that it takes 3 toggles before the user breaks out in a huge grin!

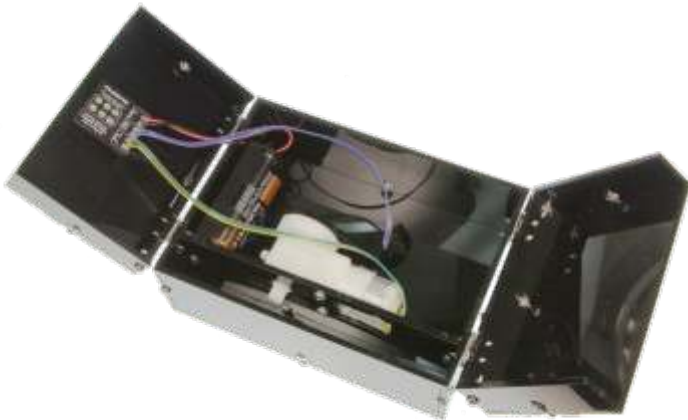

PRINCIPLE OF OPERATION

The circuit is quite straightforward. Follow along with this schematic description:

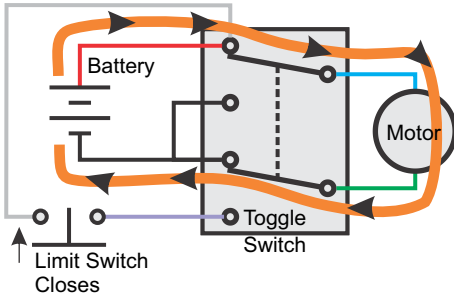

Motor is toggled on, turning clockwise, moving the arm to the switch.

When the arm starts extending, the limit switch inside closes.

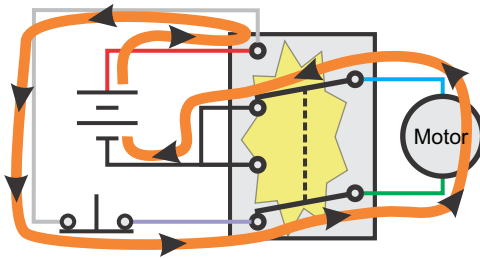

CLICK!

The motor successfully toggles the switch, and the power reversed direction.

The arm starts retracting back into the box.

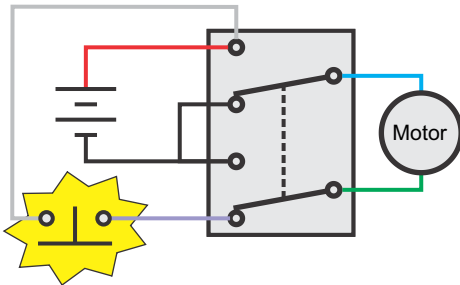

BUMP!

Fully retracted, the limit switch is pushed down, disconnecting power from the motor.

Now it's ready for another cycle!

ASSEMBLY - THE MOTOR

FIRST THING: Remove the protective brown paper from all the acrylic pieces. Yup, it's not brown, but actually shiny plastic!

Let's start from the inside and work out. Get the motor, motor mounting bolts, motor mount, the 4-conductor wire, and prepare to build!

Step 1 - Motor Mount: Prepare the motor mount by popping the limit-switch mount out from the center portion - *keep it!*

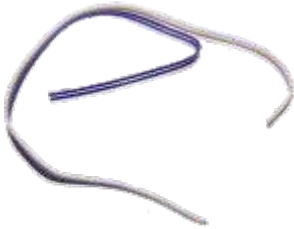
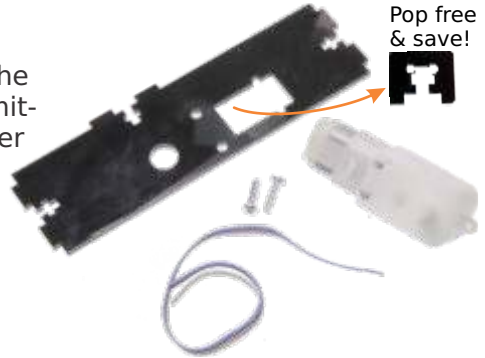

Step 2 - Split Wire: The ribbon wire actually has 4 wires side by side. Split the ribbon in half by tearing two wires away from the rest.

Step 3 - Solder Motor Wire: Take one set of wires, split the ends a bit, and peel back the insulation. Solder one pair of wires to the motor tabs (don't worry about wire color).

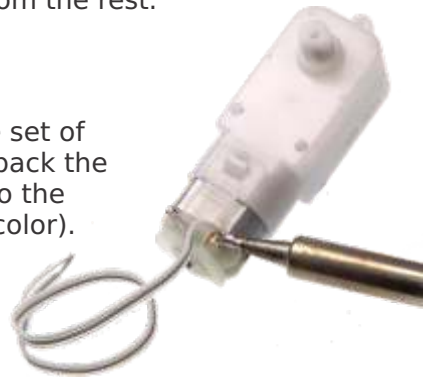

Step 4 - Motor Installation: Install the motor using the two #4 x 1/2" motor mounting screws. Arrange the motor so it fits with the wires *face-in* to the motor mount, so the shaft with the "D" shape pokes through the hole.

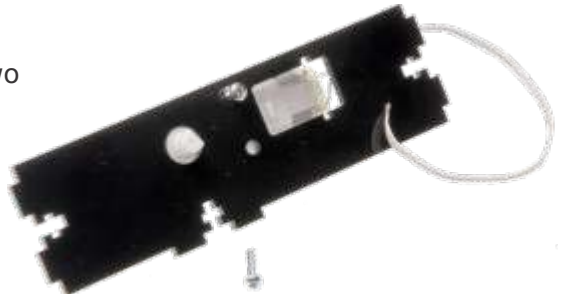

ASSEMBLY - THE FINGER & CIRCUITRY

Step 5 - Finger Installation:

The double-thickness finger makes hitting the switch much easier and more reliable.

Take the two fingers, and sandwich them together against the white accessory wheel. Screw them together with 3 #2-32 x 3/8" screws. Before you tighten the screws down, make sure the finger tips sit flush with each other.

Mount the whole assembly to the motor shaft with the #2x 1/4" screw and washer, and make sure the finger points to the top-right! Just like picking your nose, it's hard to do from the wrong direction...

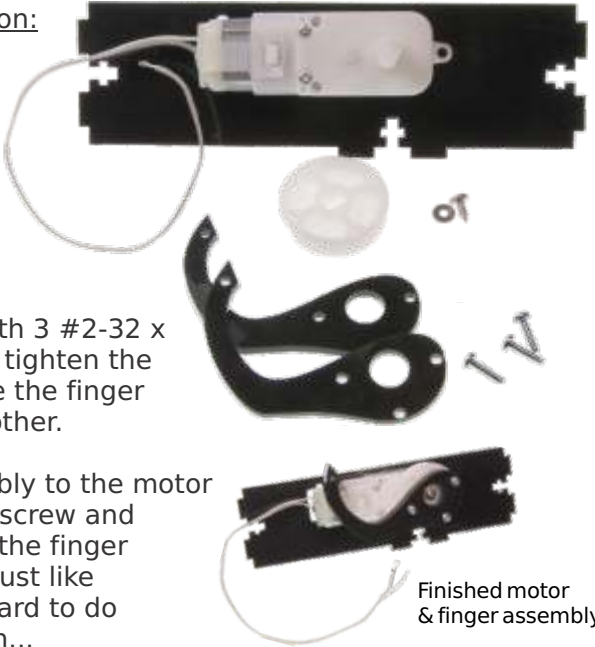

Step 6 - Circuitry: There really isn't much to the circuitry, we're simply soldering everything to the circuit board. Let's start by seeing how your finished motor assembly, Useless Circuit board, lever switch & limit switches, and the battery pack all fit together.

Begin by looking closely at this wiring diagram. The important wires belong to the motor and battery pack. Get them backwards, and your Useless Box will behave even more ...uselessly!

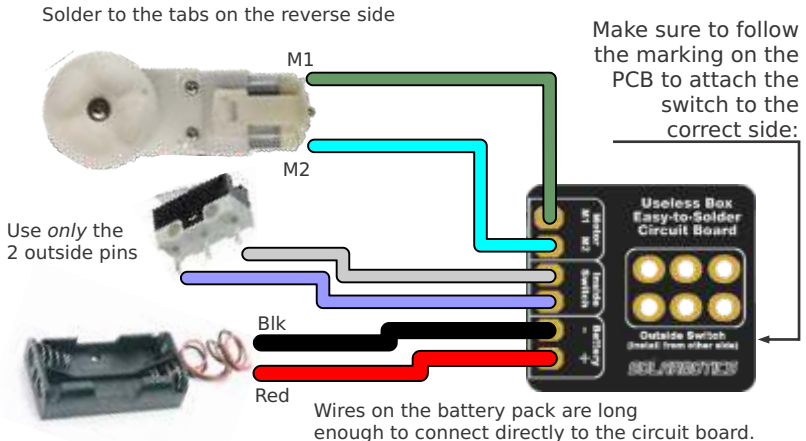

ASSEMBLY - WIRING UP THE CIRCUITRY

Step 7 - Soldering: This is the hardest part - the niggly wire-stripping and soldering of connections. Here are some tips to make it easier:

- Hold the circuit board in a vise, or use tape to hold it still while soldering, as moving targets are *much* harder to solder.
- **Pay attention to step 7d** (the last step). Wire the motor connections to the proper pads (M1 & M2)!

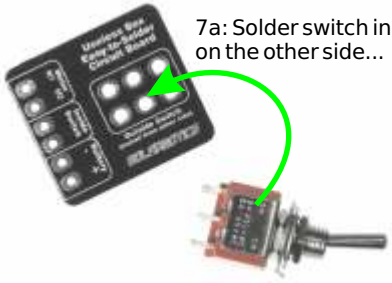

...like so!



*It's a snug fit - don't be afraid to push.

7b: Solder in the battery connector (red to '+', blk to '-')



7c: Solder in the limit switch (color order doesn't matter)

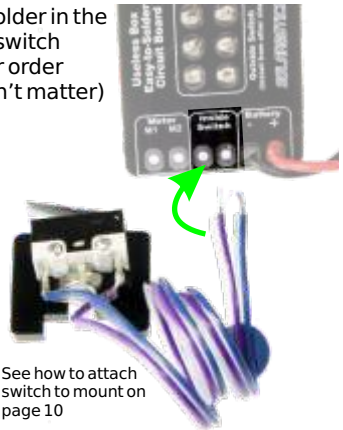

*See how to attach switch to mount on page 10

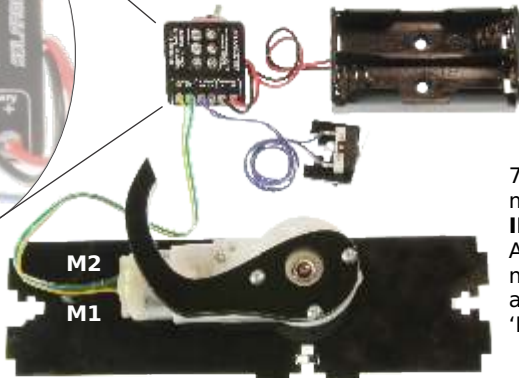

7d: Solder the motor wires on. **IMPORTANT:** Attach the bottom motor tab to 'M1', and the other to 'M2'

TESTING THE CIRCUIT'S BEHAVIOR

Step 8 - Testing: We're going to pretend there's a box around this assembly *just to see* if we got lucky and everything is wired up right.

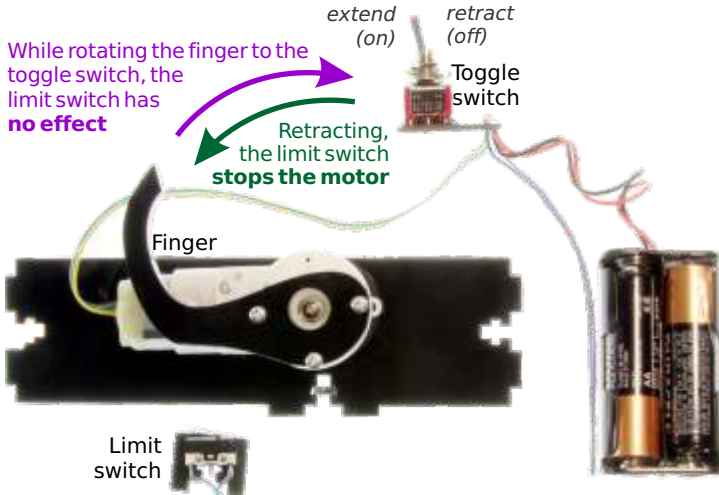

Pop in the batteries and the motor should start turning.

Test 1: Hold the limit switch down and if necessary, toggle the toggle switch. Find the position where the motor stops. This is the *retract* position.

If the motor *does not stop spinning* in one of these two positions with the limit switch down, recheck your wiring, especially to the limit switch's outer two pins.

Test 2: Release the limit switch, and flip the toggle switch the other way. Is the motor rotating the finger clockwise (fingertip going to toggle switch)?

Yes: All is well! Carry on!

No: Desolder and reverse wires connecting to the motor.

Again, to confirm the operation:

'Extend' toggle position ignores the limit switch, and turns clockwise.

'Retract' toggle position is interrupted by the limit switch, and turns counter-clockwise.

ASSEMBLY OF THE BOX

Step 9 - The Hinged Parts: Let's get the more technical box-ends completed first. Gather together:

- 2 narrower acrylic *top* box-ends
- 2 narrower acrylic *bottom* box-ends
- 4 hinges
- 16 #2x1/4" screws

Since we will be building both box ends, make sure you build them opposite to each other so they will mate properly during construction (see below note regarding the vertical slots).

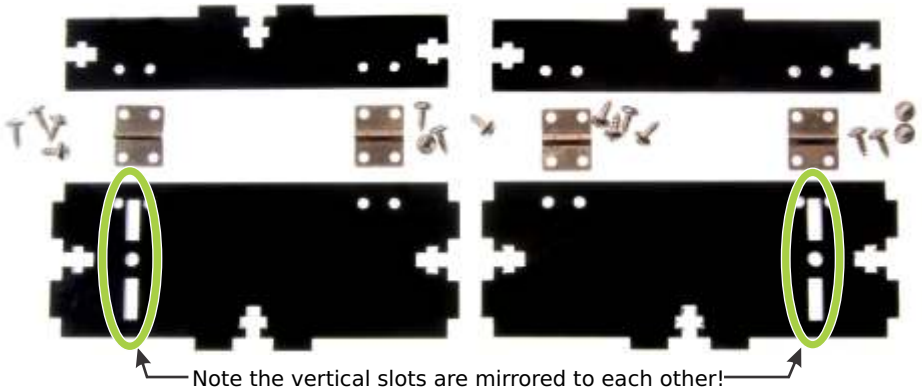

Step 10 - Exercising the Hinges: Before putting the acrylic parts together, we have to loosen up the hinges. They often are too stiff to allow the box lid to fall back properly, so bend & twist them gently (but firmly) *fully* back to the limit and forth 5 to 10 cycles.

Twisting the hinge back and forth opens up the channel the hinge pin sits in, and usually makes the biggest improvement.

Note: You only have to loosen up *two hinges* (the opening side), and only over a short range of motion. Only half the box lid opens, and only to about 20° before closing again.



ASSEMBLY OF THE BOX

Step 11 - Screw the Hinges to the End Pieces:

The parts are cut so the holes are lined up, so all you have to do is screw the hinges to the two halves. **Do not snug-down the screws!** We want the hinges to sit a bit "sloppy" until the rest of the box is assembled and aligned.

Remember to make the ends mirror each other, so one has a vertical slot on left, and the other has a vertical slot on right.

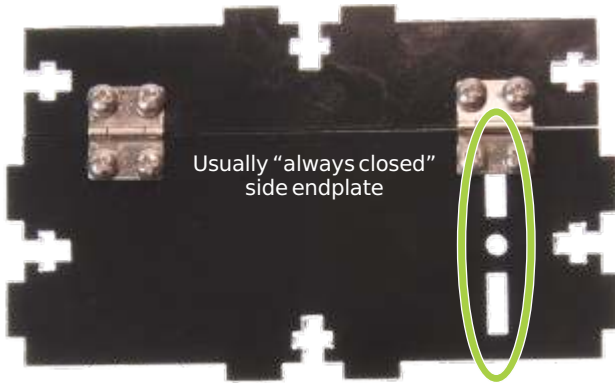
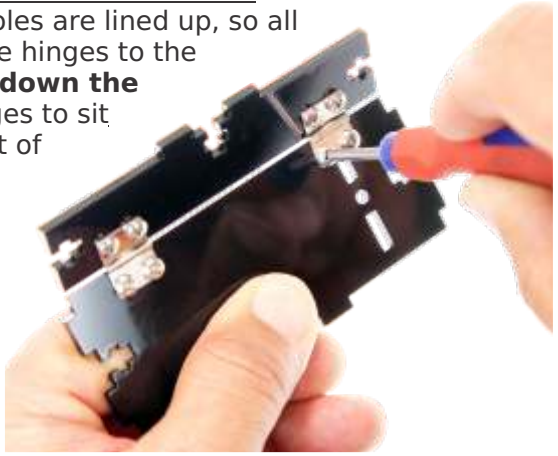

One has slot on right,
the other on the left.

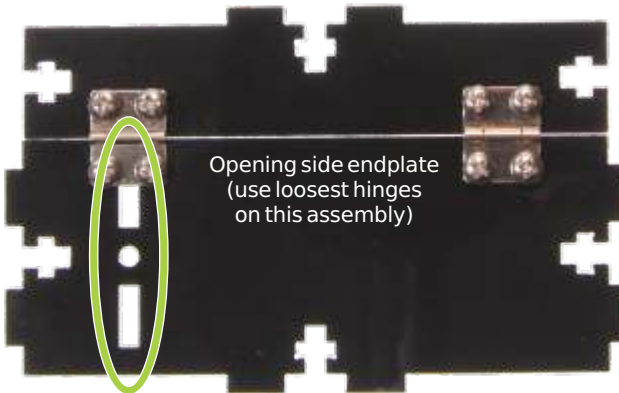

If you accidentally use too much force and strip the plastic (so the screw doesn't "bite" anymore), use this backing plate where the screw comes through to give it more material to bite into.

ASSEMBLY OF THE BOX

Gather the remaining parts and the motor control circuitry we tested earlier. Time to get it all together!

Step 12 - Limit Switch

Mount: Find the small limit-switch mount from Step 1, and the two remaining #2-32 x 3/8" screws.



Put the assembly together with the screws passing through the mount, and threading into the limit switch body. Pay close attention to the photo on the right, to make sure that it's mounted on the proper side with the correct orientation.



Step 13 - Arranging Main Box Parts: Let's make sure everything is ready. You've got the tested circuitry & motor mount, two completed box ends with hinges, and the long, large box sides. Good! Let's start final assembly!

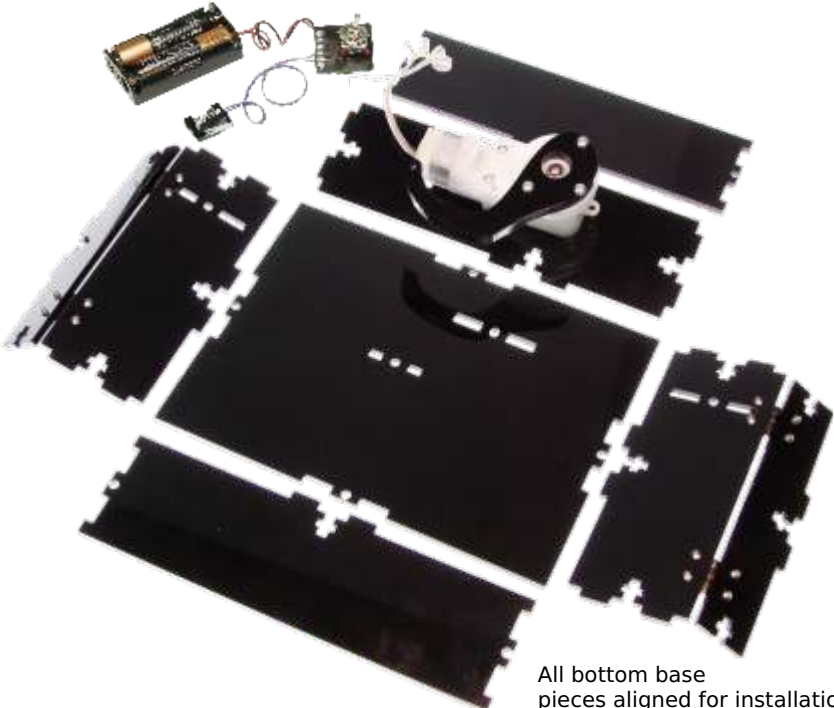

All bottom base pieces aligned for installation

ASSEMBLY OF THE BOX

About T-Slot Construction: The box is built using the “T-Slot” construction, which is a common technique used with laser-cut profiles (see http://bit.ly/T-slot_laser for more about this method).

General Assembly Technique: Slide a nut into the top slot of the “t”, using a little tape if necessary (mostly for tight spots where you can’t fit your finger). If you still find it hard to press the nut in, try going in from the other side.

The notches in the box are aligned so that mating parts nest together. Align them, and put a #4 3/8” bolt through the hole into the nut. *Be careful* when tightening the screw! Just a ½ turn more than finger-tight is fine! **Do NOT over-twist the nuts & bolts.** Use only hand-screwdriver (not powered) for assembly!

We *will* send out a free replacements parts for ones broken during assembly (please send photo of part, if possible).



1. Insert nut



2. Place 2nd part, screw in bolt



3. All secure & tight!



4. Finished connection

ASSEMBLY OF THE BOX

Step 14 - Limit Switch and Motor Mount: Using your new T-slot assembly skills, install the limit switch to the mounting holes nearest the center of the box base. Make sure to have the switch body facing away from the motor.

Secondly, install the motor mount behind the limit switch, and screw it to the base. Take a moment, and confirm that the motor fingers squarely hit the limit switch.

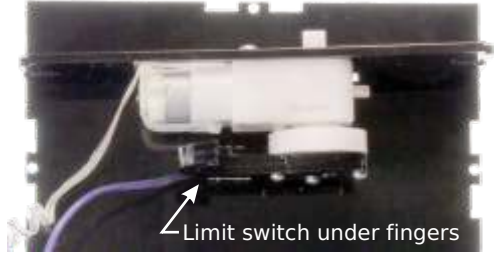

Step 15 - Main Box Walls: Start with the hinged end pieces, align and install them to the tabs on the box base and tabs on the motor mounts. Again, use the #4 nuts and bolts and lock them down.

Finish the bottom assembly by adding the big side-pieces, locking them to the base and end pieces with more #4 hardware.



Finished base
parts installation

ASSEMBLY OF THE BOX

Step 16 - Build the Lids: Let's get the lids built. The only thing to be careful of is to arrange the holes on the end of the side parts to be on the same side as the holes on the lid tops.

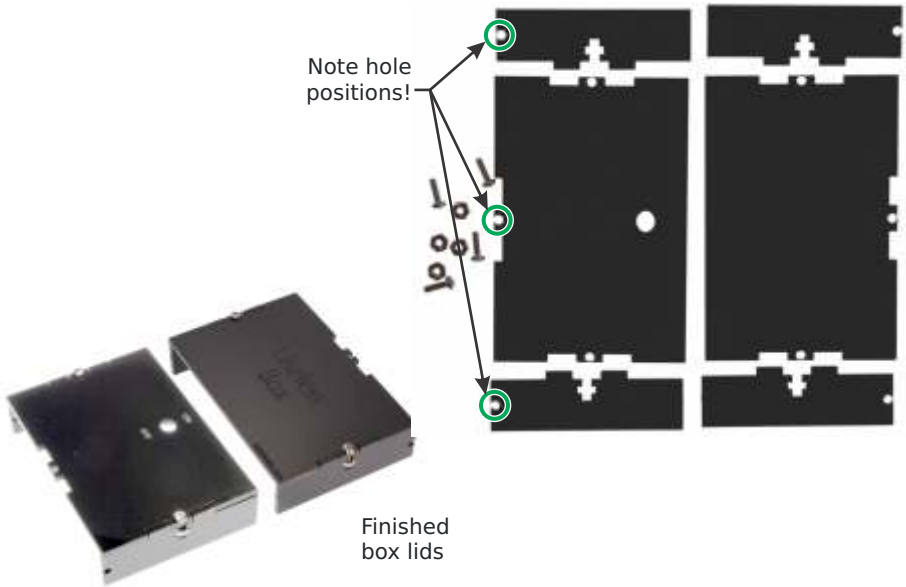

Step 17 - Install the Lids: Mount the lids to the hinged end pieces, with the "On / Off" hole lid to the *right* of the motor, so the finger will swing over top of the hole. When the lids are both installed, make sure they are sitting square to the frame, and tighten down the hinge screws.



TEST & TUNING

Step 18 - Alignment Check: Lift the lid labeled “Useless Box” 20 degrees, and see if it slaps back down. If not, re-loosen and re-align the hinge screws (loosen, open lid a bit, re-tighten), and repeat until you get a nice closing action.



Step 19 - Switch & PCB Installation: Remove the top nut & washers on the switch, and install the switch & PCB assembly into the hole from underneath. Use just one washer and the nut to hold it in.

Note: Make sure the PCB is oriented the right-way around, which is *so you cannot see it; it is hidden from view.*

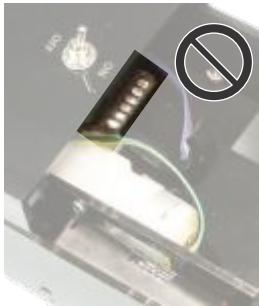

Wrong way!
(shouldn't be able to see this)

Correctly installed
(PCB is hidden)



Step 20 - Battery Pack: Install your batteries, and tuck the pack in by the motor, or use the double-sided sticky tape to stick it down to a spot within the box that doesn't bother the motor finger.

Step 21 - Final Tuning: Close the lid, and *throw the switch!* Watch the finger come out of the box and hit the switch - if it doesn't hit the switch, loosen the top nut and shift appropriately to get the alignment right (then tighten the nut back down). If that isn't enough adjustment from the hole, you can loosen the motor mount bolt on the bottom of the box, and shift it left or right to assist in alignment.

Step 22 - Rubber Feet: Don't forget to attach four rubber feet so that your finished assembly doesn't slide around.

TROUBLESHOOTING & WRAP UP

Hopefully, your Useless Box is fully functionally... useless! If not, there are only a few things that might cause problems:

Does the finger push up on the lid while it's trying to turn itself off?

Some switches need more force than others, which can make the finger lift the lid with the toggle switch.

There are 3 solutions. The easiest is to tape the lid closed (on the inside of the box so it looks clean). The next is to use the height nut on the switch to make it a bit shorter, but this is a fiddly process. The *preferred method* we've found is to use a file or sandpaper to shape a more aggressive angle to the fingertip.

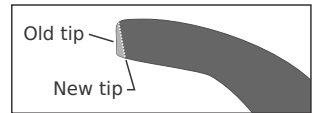

Does the finger skip off to one side of the switch?

As mentioned before, you can adjust the alignment of both the switch and motor.

Motor is not able to activate switch?

Chances are you need a fresh set of batteries!

When you're fully happy with how it's working, use tape, wire or zip-ties to bundle the wires, which will make them less likely to snag and break. Besides, it make the installation look so much cooler when your guests finally open up the box!

Looking for some tips on soldering? Check out this video:

<http://slrbtcs.co/UQEse0>

As with most things useless, have fun with it!

Visit us online for more info and cool stuff:

www.solarbotics.com

Solarbotics Ltd.

3740D - 11A Street NE, Suite 101
Calgary, Alberta T2E 6M6
Canada



Toll Free: 1-866-276-2687

International: +1 (403) 232-6268



Fax: +1 (403) 226-3741



This work is licensed under a Creative Commons
Attribution-ShareAlike 3.0 Unported License.