

Solarspeeder Solaroller[®]

**Solar-Powered Racing,
in the Palm of your Hand!**

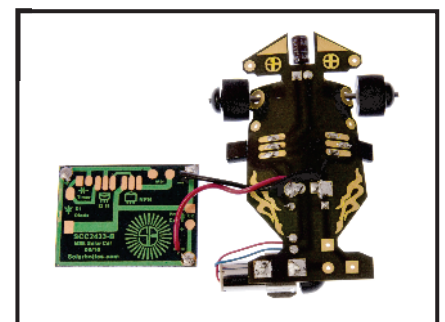
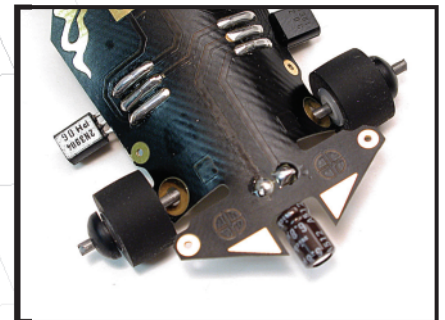
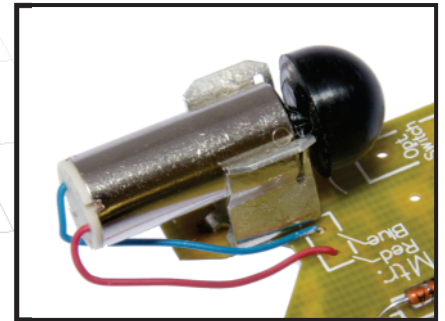
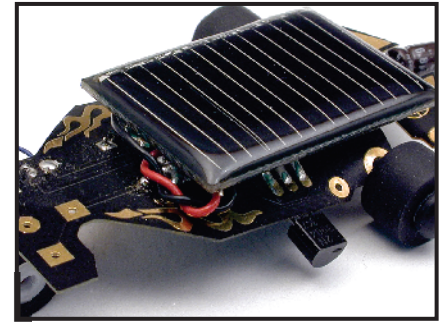
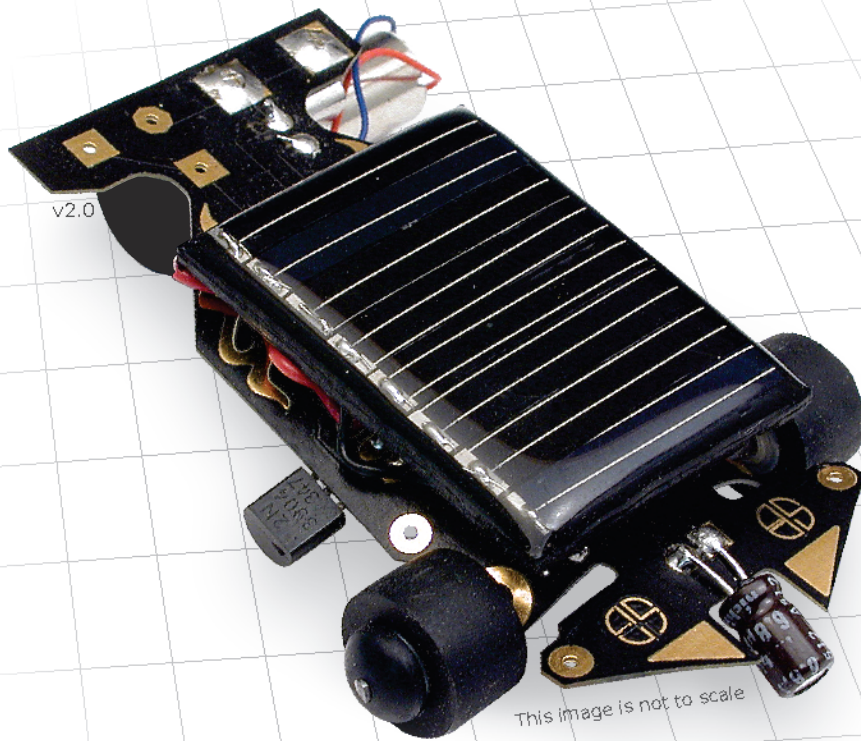

Small, quick, and simple, the SolarSpeeder is an easy project that uses the sun to power the fastest electronic solar car kit in the world!

***Built for Speed
Powered by the Sun
Designed for Easy Building***

Skill Level: **Build Time:**



Beginner
(Soldering
Req'd)

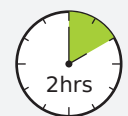

www.solarbotics.com
1-866-276-2687

This page is *unintentionally* left blank.

That's right - we had all sorts of cool stuff on this page, like the answer to life, the universe and everything. And then Guido the Office Gremlin made happy with the white-out. Oh well.



SolarSpeeder 2.0 Parts & Materials List

Here's all the things you should have and will need to finish the project. If you are the suspicious type of person who wants to make sure you're getting everything you paid for (we're like that too), use the little check-boxes to mark off the parts before you get started.

Mechanical Parts

- (1) SolarSpeeder 2.0 Printed Circuit Board (PCB)
- (1) High-efficiency Coreless Motor (SKU: RPM2)
- (1) Motor Mounting Clip (SKU: MMFC)
- (3) Rubber Wheels on Nylon Hubs (SKU: RW)
- (1) 43mm long 1.40mm diameter (1.8" long, 0.055" diameter) Steel Rod
- (2) Black Plastic Wheel Retainers (SKU: PRet)
- (1) Square of Double-sided Sticky Tape (also known as 'DSST')

Electronic Parts

- (1) 0.35F 2.5V Gold Capacitor (SKU: CP0.35F)
- (1) 6.8 μ F Electrolytic Capacitor (SKU: CP6.8E μ F)
- (1) 3904 Transistor (SKU: TR3904)
- (1) MCP112-240 Voltage Trigger (SKU: MCP112-240)
- (1) Diode (SKU: D1)
- (1) 24x33mm Solarcell (SKU: SCC2433B-MSE)
- (1) Length twisted red/black wire

Tools Required

- Soldering equipment (soldering iron / solder / cleaning sponge)
- A pair of Needle-nose pliers
- Safety Glasses - VERY important when clipping and snipping!

Substitute parts may be provided, but all parts necessary to successfully complete your SolarSpeeder should be included.

Disclaimer of Liability & other Legalese (i.e.: stuff to keep the Lawyer happy)

Solarbotics Ltd.® is not responsible for any special, incidental, or consequential damages resulting from any breach of warranty, or under any legal theory, including lost profits, downtime, good-will, damage to or replacement of equipment or property, and any costs or recovering of any material or goods associated with the assembly or use of this product. Solarbotics reserves the right to make substitutions and changes to this product without prior notice.

"SOLARBOTICS" is a trademark of Solarbotics Ltd. Reg. CIPO / USPTO.

"SOLARSPEEDER" is copyright, Solarbotics Ltd. 1996

Be careful! We will help you any way we can to make sure you have a good time and get this project built successfully, but we're not responsible for putting band-aids on any burns and other ouchies you get while soldering, clipping, snipping, etc., etc...

REMEMBER: Always wear your safety glasses, and use proper safety techniques!

Introduction - The SolarSpeeder Solaroller

The SolarSpeeder is a design that has a strong heritage in Solaroller racing, a very popular event at BEAM Robot Games.

Solaroller racing has two solar-powered cars race side-by-side down a one meter (3.3 foot) track. Early in the history of Solaroller racing, the one-meter times were in the 10 and 20 minute range, but as electronics improved and mechanics got more efficient, the elapsed times dropped to 6 minutes, then 2 minutes, until now they complete the meter in less than 20 seconds!

Your SolarSpeeder was designed using the qualities of the fastest racers, which allow it to travel over 3 meters (10 feet) with only 1 minute of direct sunlight!

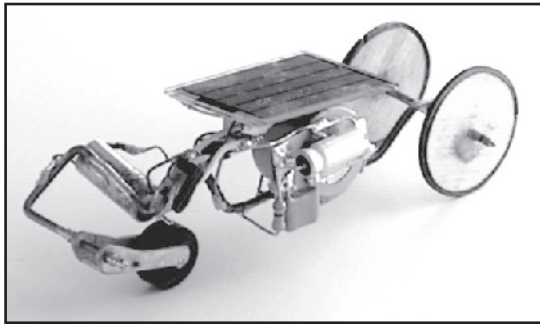

"Sluggy, Too" - Ex-Champion Solaroller with a record at 2 minutes, 9 seconds (1994)

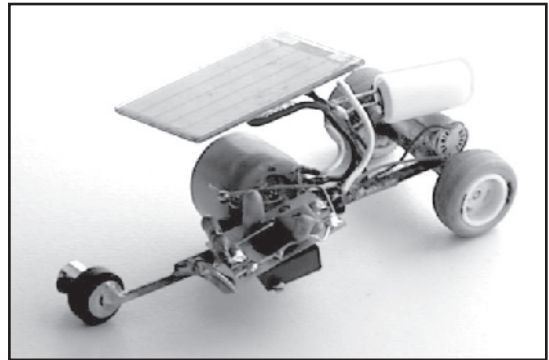

"Scooter" - Solaroller with best record of 2nd place (1995) at 1 minute, 4 seconds. Beat 2nd place by only 1 second. 1st and 3rd place won by 11 year old boys!

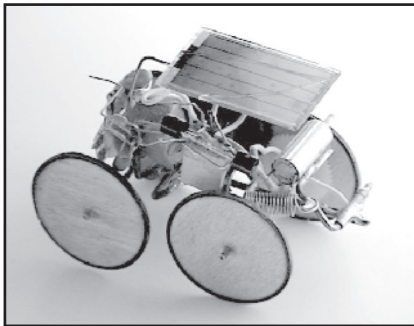

"Herbie" - 4-wheel drive Solaroller designed for rough-terrain Class-B Event. Almost as fast as "Sluggy, Too"!

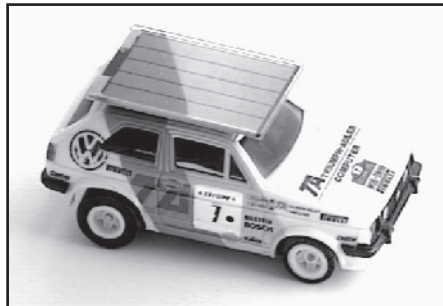

"SC-1" - Modified Slot-car racer. One of first Solarollers to use high-performance "Miller engine" technology.

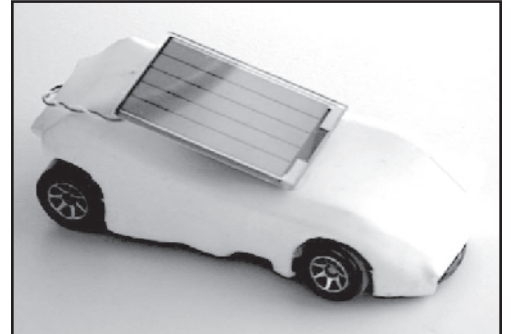

"SolarSizzler" - Early SolarSpeeder prototype that utilizes a soft rubberized shell.



Parts!

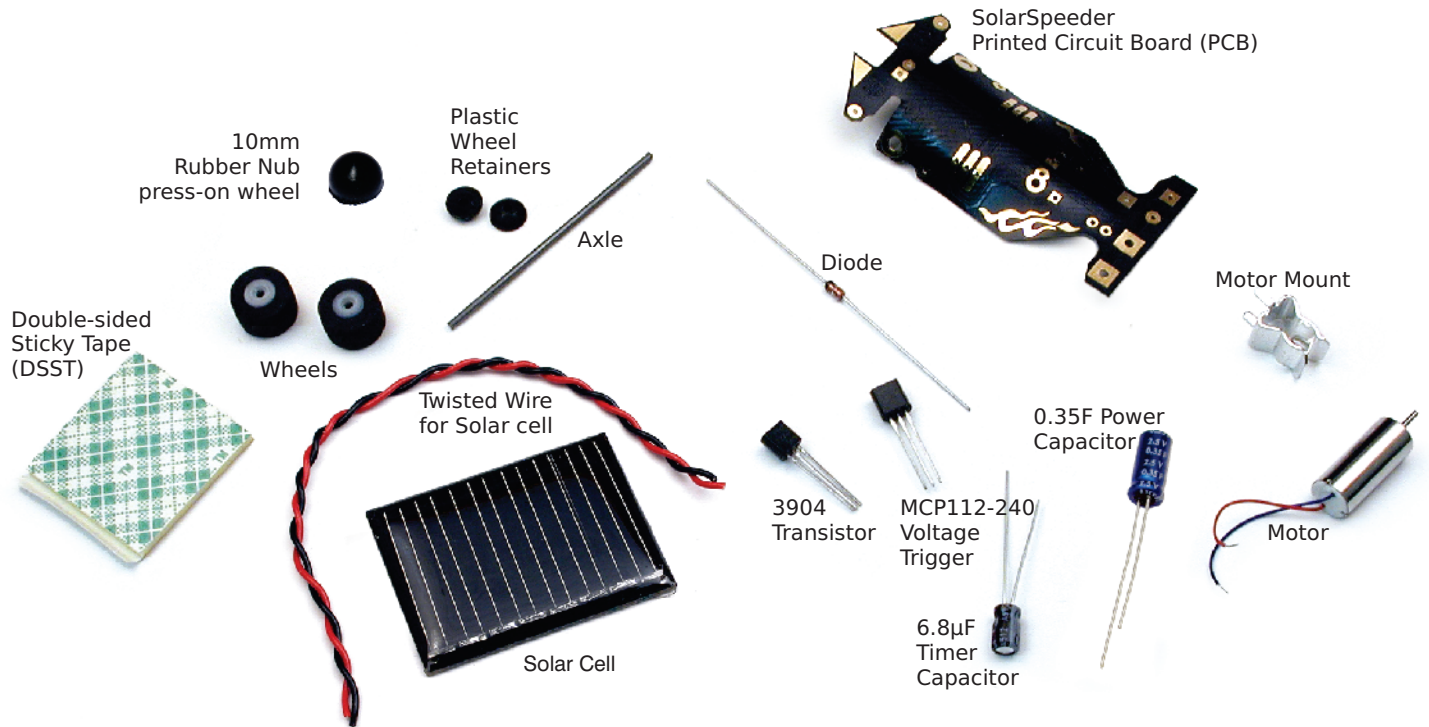

The body of the SolarSpeeder is also its “printed circuit board”, usually called a “PCB”. The gold flames make it go fast. Really! Why else would people paint them on cars?

The 0.35F capacitor stores the power from the solar cell. It’s really powerful for its size. The smaller 6.8μF capacitor is the timer capacitor, which tells the SolarSpeeder how long to stay on when it activates. If you want your SolarSpeeder to fire in many short bursts, replace the 6.8μF with a smaller one.

The motor we use is a high-quality “coreless” motor, which means it is designed for high-speed and efficiency. This is what gives your SolarSpeeder ZIP!

The 3904 transistor is the “muscle” in the circuit, which pipes the power to the motor. It holds the power back until it’s time to activate.

The MCP112 voltage trigger looks like the transistor, but acts more like a fuel gauge. It watches the 0.35F power storage capacitor. When it’s almost full, the MCP112 tells the transistor to turn on.

The solar cell we use is actually quite powerful for its size. You’ll get best power out of it by using it in direct sunlight, or under a strong halogen or incandescent bulb lamp. Don’t try using it with flourescent lights - they’re terrible to use with solar cells!

Theory

The circuit is normally off, so the solar cell stores all its energy in the 0.35F storage capacitor. The MCP112 sits and watches the voltage stored in the 6.8 μ F C2 timer capacitor, which is also being charged, but through the D1 diode.

When the stored charge reaches approximately 3.2 volts, the MCP112 turns on, and sends a "high" signal to the 3904 transistor, which turns it on like a switch. The power then flows out of the storage capacitor, through the motor, through the transistor, and back to the other side of the capacitor.

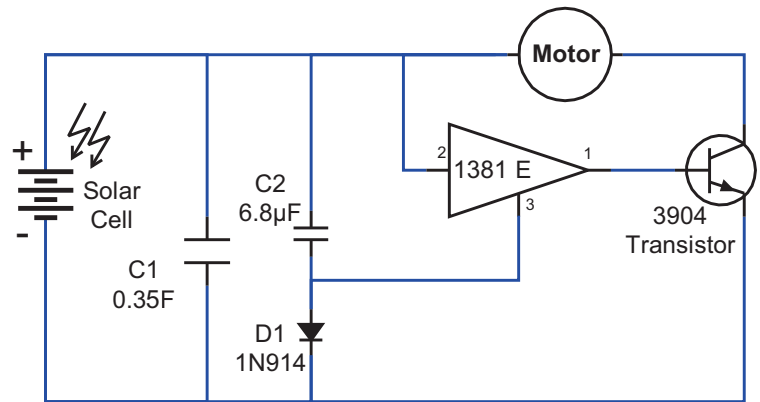

Because the C2 timer capacitor is blocked from the power part of the circuit by the diode, the capacitor discharges much slower out of the MCP112. If the MCP112 was watching the main power capacitor, it would reset as soon as the power dipped below 2.2V, but since it's watching the protected C2 timer capacitor, we've tricked it into staying on much longer, giving your SolarSpeeder much more time to zoom!

Soldering Tutorial

The most important skill needed to successfully construct your device is soldering. Make sure you start by using electronics solder, not plumber's solder. The main trick to getting a successful solder connection is to heat the junction up before applying the solder to the heated area. Do NOT try to melt some solder onto the tip of the iron and smear it onto the joint - you won't get a strong joint. You're a roboticist, not a painter!

If the heat is applied unevenly, you will get solder blobs (see below). To better apply heat, keep your soldering iron tip clean by wiping it frequently on a damp sponge or cloth. The tip should always be shiny, and not covered in tarnish and burned crud (don't burn crud - bad!).

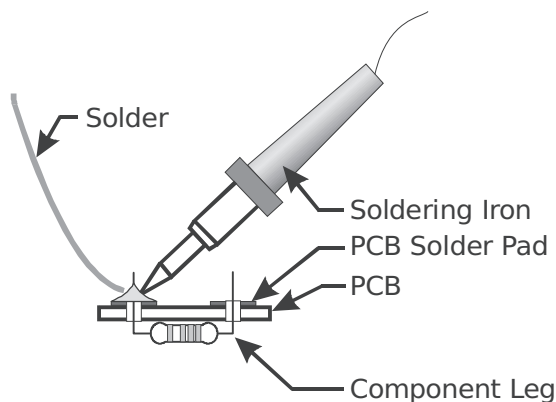

Bad & Good Solder Joints

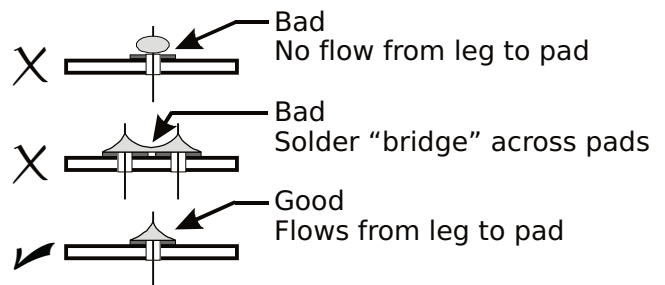

Remember to take your time. Don't rush. It's almost impossible to "burn up" these parts!



Construction - Electronics

Let's get started. Start by opening your bag of parts, and dumping them into a safe place like an egg-container (remove eggs), pie-plate (eat the pie), or cat-food bowl (give cat away to gypsies). Don't simply spread them about on a table-surface where they'll roll away, because then you'll think we forgot something in the kit and have to call us. Then we'll tell you to look under your chair, and you'll find it there and think we have magic powers.

In short, keep your parts safe when you dump them out - they're small, and will try their hardest to hide from you!

Step 1: Steel Axle Installation

Slide the axle through the holes labeled "rod" so it's about centered.

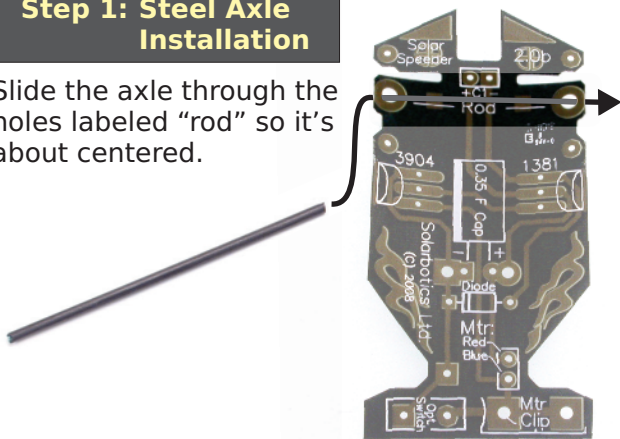

Step 2: Bending the 0.35F Capacitor Leads

To make the **0.35F capacitor** fit, we need to bend the leads down right against its face.

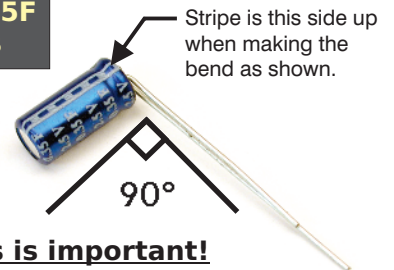

Hey - PAY attention! This is important!

Don't make me move you to the front of the classroom... When you insert the capacitor, the stripe (which shows the '-' lead) **must** match the stripe printed on the circuit board. To make this happen, you have to bend both the leads over like the image here!

Step 3: Install capacitor into the '-' and '+' holes.

Insert the 0.35F capacitor into the position shown, turn everything over, and solder the capacitor leads in. **SNUG IT UP** right to the circuit board.

Remember the soldering tutorial at the beginning? Now would be a good time to refresh your memory. Go forth, and solder!

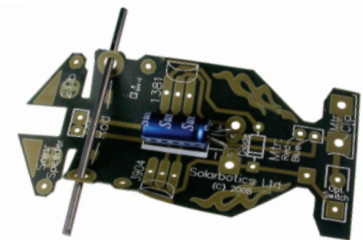
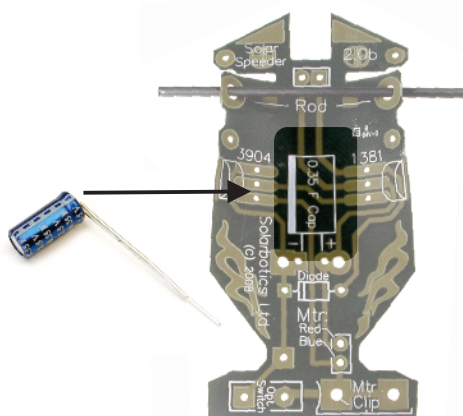

This is what you should have after soldering the capacitor in place.

Step 4: Bend Diode

The diode needs to be installed correctly, just like the capacitor. It has a black band on it that has to match the band mark on the PCB.

Bend the legs up so it fits well into the holes in the 'Diode' spot.

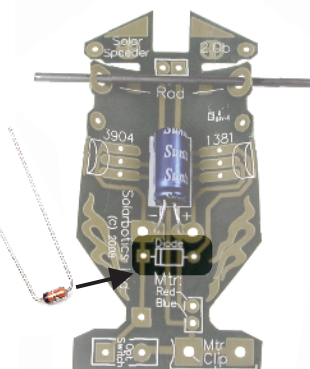

Step 5: Install Diode

Install and solder the diode to the spot marked 'Diode'. Yes, we're gonna say it again:

Make sure the band matches the location of the band on the PCB.

It won't work very well if it's in backwards! Still not sure? Compare yours to the next picture to be sure it's in right.

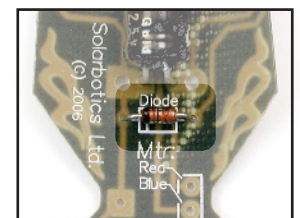

Diode installed. Note the band is on the left!



Construction - Electronics

Step 6: Install Transistor

Two important things to remember during this step:

- A) Install the transistor FACE down (flat side down).
- B) Install the transistor with the head poking past the edge.

Find the transistor, which is marked '2N3904'. The picture shows it face up (for your reference). You **must** install it face down, so you see the curved backside of the transistor, like it's shown drawn on the PCB. Install it face up, and it won't work! Sure, you can still sleep face up or face down, but a transistor is a wee bit more picky than you.

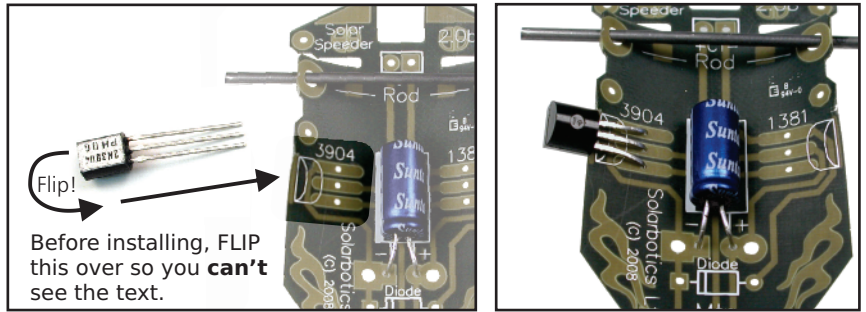

It's also important that you install it so the head of the transistor is poking out past the side of the PCB. This keeps the transistor from rubbing the ground when the SolarSpeeder zooms off.

Step 7: Install MCP112 Trigger

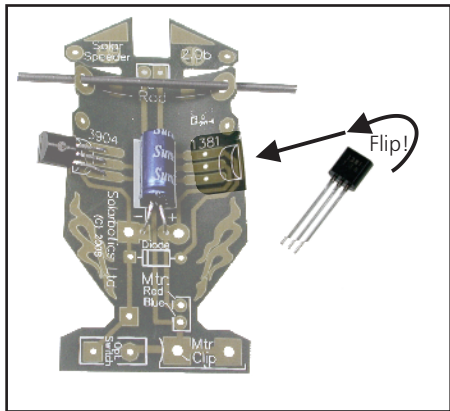

Just like before, there are two important things to remember:

- A) Install the MCP112 FACE down (flat-side down).
- B) Install the MCP112 with the head poking past the edge.

The MCP112 looks like a transistor, but it's a *bit* larger. And tastes different (just kidding).

Flip it over, and install it in the spot '1381'. Again, you **must** install it face down. Make sure the head sticks out a bit from the edge, like you did for the transistor.

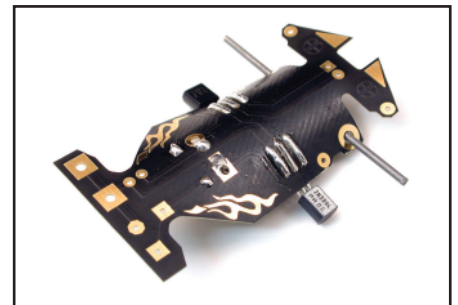

Completed transistor & MCP112 installation. See how you see the flat faces with writing on them, and how they poke out past the edge?

Step 8: Install 6.8µF Capacitor

Like the big first capacitor we did, this one needs to be installed the correct way around.

Figure out the negative (-) side by examining the capacitor. The side with the stripe mark is the side with the negative lead.

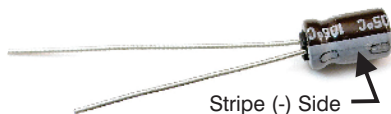

Insert the capacitor into the holes at spot 'C1', as shown. You'll see that C1 has a round and square pad - the negative lead goes into the square one. And like the transistor & MCP112, lay it flat with the head sticking out a bit.

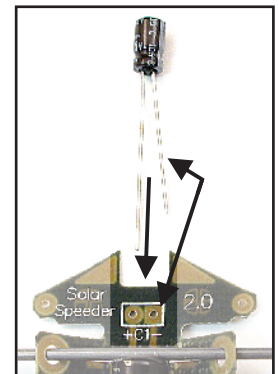

Stripe (-) side (shorter!) goes to square pad



Construction - Motor, Wheel & Mount

You'll find it easier to solder in if you fold the leads over on the other side - it's a small part, and it won't run away if you do this.

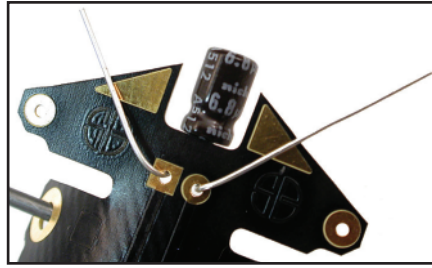

Fold leads over to make soldering easy!

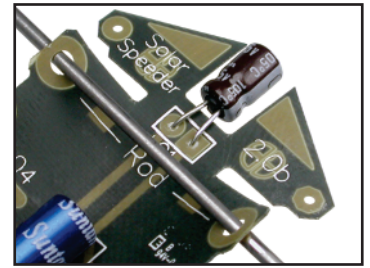

Finished capacitor installation

Step 9: Mounting the Wheel to the Motor

To keep things easy, we're going to mount the wheel onto the motor before installing the motor.

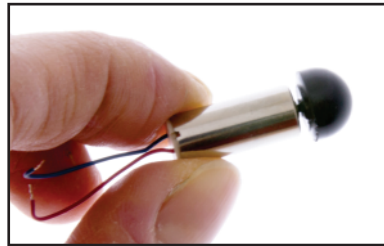

Step 10: Install the Motor Mount

In a previous life, the motor mount was used for holding fuses. We use it for holding the motor. The only way it could be better is if it came with free chocolate...

Look at the mount carefully. You should notice that one side has some little tabs. We want to install the mount so the tab-side is towards the middle of the SolarSpeeder, nearest the curve symbol on the PCB.

Stick the legs of the mount into the holes, and get ready to solder. Or not. What we mean by that is that *if you want*, you can simply bend the legs over to hold it on - they're strong enough. Or, you can be traditional and solder it on. We did both by folding one over, then soldering. No real advantage doing it either way. You choose.

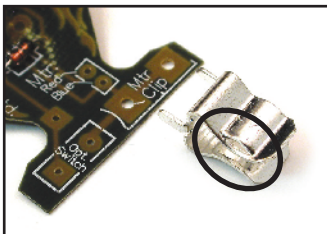
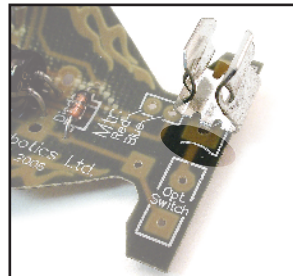
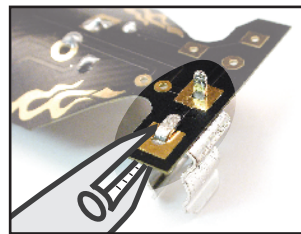

Figure out what side of the mount is the tabbed side (circled here)



Insert the mount legs into holes, tabs nearest the 'J'



You have a choice: Just solder it, OR, pinch the legs over flat with needle-nose pliers...

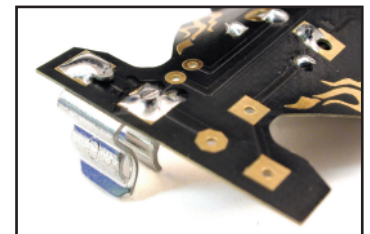

...then if you have to, clip the leads! Here, we left one unfolded-over, but soldered them both (just to be wild - wheeee!).

Construction - Motor Installation

Step 11: Install the Motor

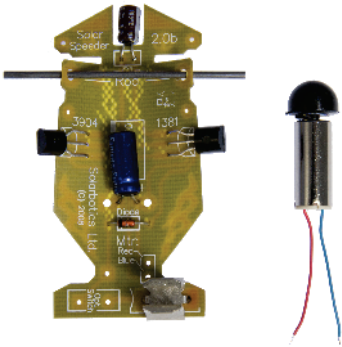

Remember that motor & wheel thing we put together earlier? Time to rescue it from the mouth of your cat or little brother/sister (yuck...). After wiping it clean, you should see the motor's blue and red wires. Pay attention now; we don't want to mess up this next step: Solder the RED wire to the spot labeled "Mtr Red". Solder the BLUE wire to the spot labeled "Mtr Blue".

Tricky, eh? We knew you could handle it.

After the motor is soldered to the SolarSpeeder, snap the motor into the clip, with the front face of the motor shoved right up against the motor holder clip. If the wheel rubs the motor mount, then gently pry the wheel out a bit so it has some space clear.

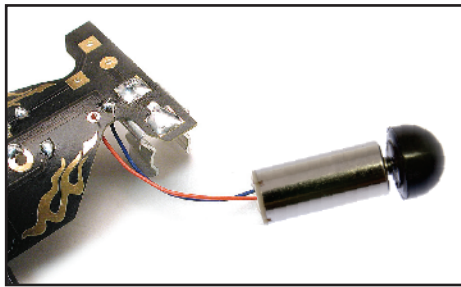

Insert the wires from the bottom. If you fold a little hook on the wire poking out the end, it'll grab the edge so you can solder it.

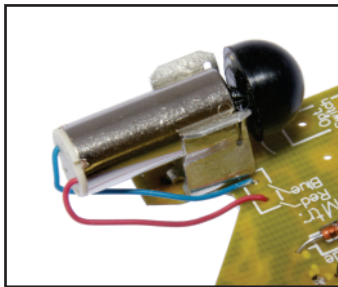

Solder Red wire to 'Red'; Solder Blue wire to 'Blue' Tricky, eh?

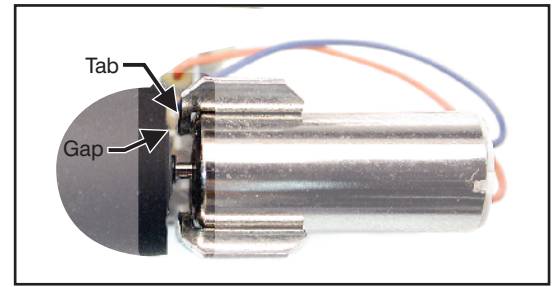

Snap the motor into the clip. See how the tabs on the motor mount are snug to the motor face, and how there's space for the wheel *not* to rub?

Step 12: Mounting the Front Wheels

Let's make this thing look more like a little race-car, shall we? Let's mount the front wheels.

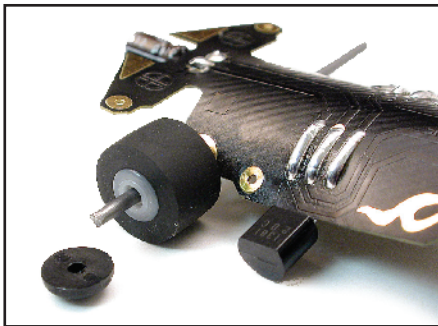

Find the two little plastic nubs and the remaining two wheels. Can't find them? What's your pet chewing on? Not in the mouth, anymore? You may have to wait 24 hours...

Once you've found all the parts, pick one side, and slide the wheel onto the axle. Place the nub on the table (curved side down works best), and place the tip of the axle into the nub's hole. Use something other than your finger to push the axle onto the shaft! Why? You're gonna poke a nice, neat hole into your finger - trust us, we've ~~done~~ seen it too many times! Use the handle of your pliers to tap it in.

Put one wheel on the axle, and put one nub (curve down) beside it.

Repeat the process on the other side, and adjust the nubs so the wheels spin free, but don't slop back'n'forth too much.

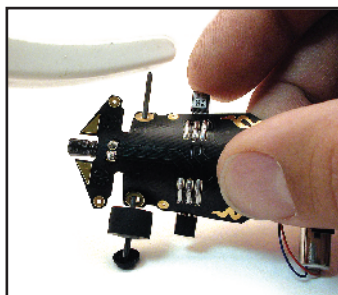

Use the handle of your pliers to tap the axle into the hole of the plastic nub.

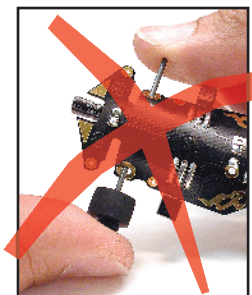

OUCH! Want to pierce your finger? No, no, no!

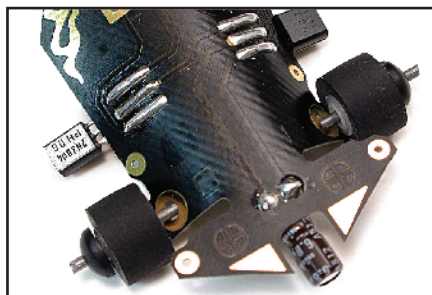

Finished! Wheels spin easy, and don't shift about on the axle!

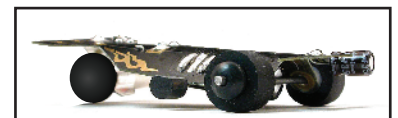

Ready to roll! Nothing rubbing or touching!



Construction - Solar Cell Installation

Step 13: Solar Cell Preparation

We're using a Solarbotics *SCC2433b-MSE* solar cell, which means it has its own circuit board on its back. We're not using it, so ignore it. Pay it no attention, and it will stop bothering you. We're just going to simply solder wires to the solar cell, nothing more. Just wires. Don't get any ideas, mister...

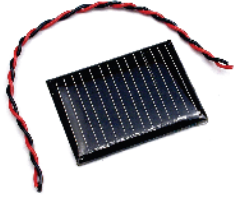

Twisted wire, and solar cell, ready to go!

Take the red & black twisted wire, and unravel each end a few turns. Easy.

Strip off 3mm (1/8") off the end of each wire. We gave you lots of wire, so if you mess up a bit (like accidentally snipping the end right off), you've got more to work with. If you have a wire stripper, it's easy. Otherwise, use the wire cutters (gently cutting just the insulation), or if you have strong thumbnails, pinch the insulation off.



Strip 3mm (1/8") off each end.

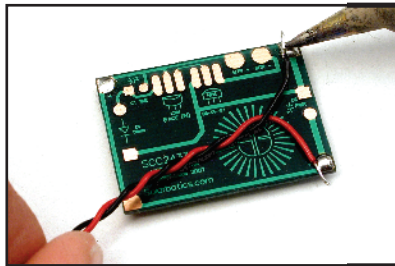

Solder black to '-', red to '+'

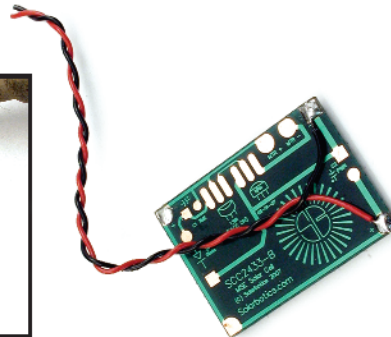

Finished! Ready to attach!

Do NOT use your teeth to strip wire! Wire is not dental floss! Trick kitty into doing it for you.

Once you've got all four ends ready, solder one end of the wires to the solar cell. Black wire to black dot ('-'), red wire to red dot ('+'). Simple!

Step 14: Solar Cell Installation

Another simple step - boy this is fun, ain't it? Get your SolarSpeeder, and lay the solar cell wires down on top. If you look close, you can see a '+' and '-' under the black stuff.

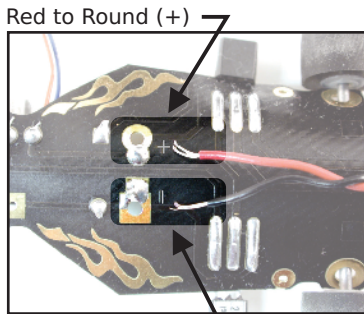

Black to Square (-)

Solder the black wire to the '-' (square) pad, and the red wire to the '+' (round) pad.

Now your SolarSpeeder is technically alive! Before attaching the solar cell to the SolarSpeeder, check that the motor spins by holding it under a bright light (not fluorescent!). That big bright ball in the sky works well.

It will take about a minute of direct sunlight, so be patient. Watch the squirrels scamper, or count the seconds on your wristwatch, but give it some time to charge. If it works - hooray! Continue to the next step. If it doesn't work (boooo...) you must fix it now, while it's easy. Go directly to troubleshooting. Do not pass 'Go', do not collect \$200. (Play "Monopoly" when you're not building robots!)

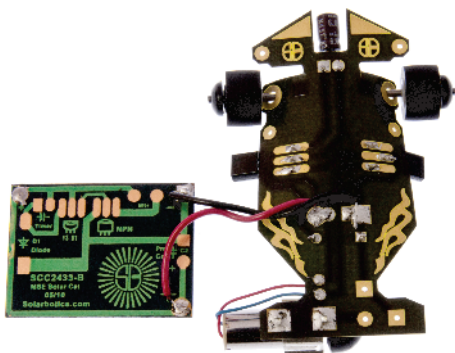

Finished soldering the solar cell to the SolarSpeeder! Time to test!

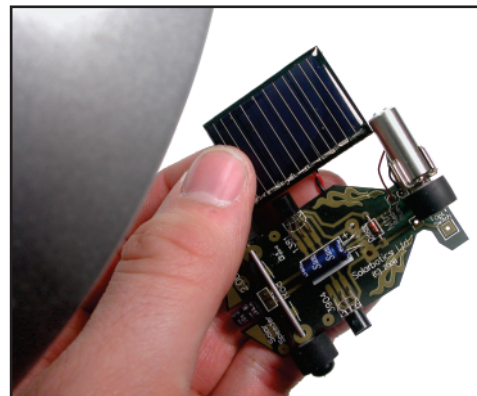

Testing the SolarSpeeder under the lamp. Give it 3 minutes!

Construction - Completion!

Step 15: Solar Cell Clean Up

This step is optional.

We gave you lots of extra solar cell wire so there's extra in case of mistakes.

Trim off the wire 12mm ($\frac{1}{2}$ ") past the long end of the solar cell. Do a tidy stripping job on the wires (you should be good at this by now). Resolder the wires to the SolarSpeeder, and lay the solar cell back down. See? Doesn't that look better?

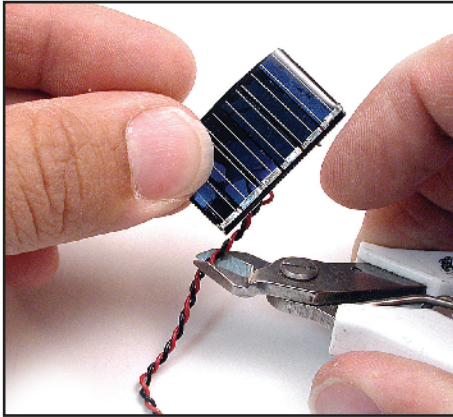

Clip off the wire 12mm ($\frac{1}{2}$ ") past the long end of the solar cell.

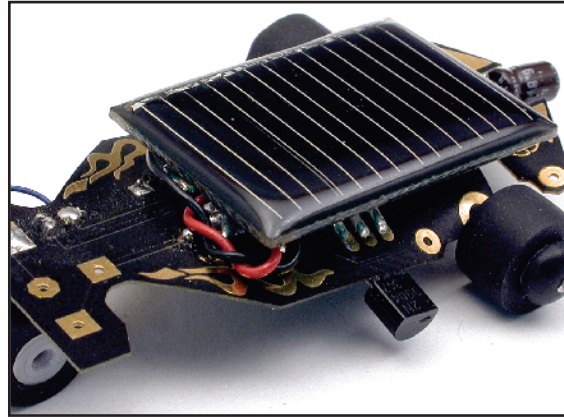

Strip the ends, and solder the solar cell back on. Doesn't that look much neater now?

Step 16: Solar Cell Mounting

This is easy (bet you knew we were going to say that, right?). Now that your SolarSpeeder motor went "ZRMMmmmm...", you're ready to finish the assembly.

Take your double-sided sticky-tape (hereafter referred to 'DSST', ok?), and peel off one side. Fold it in half so it sticks together.

Peel the other side off, and stick it to the underside of the solar cell. If you put it on the top of the solar cell, you *really* shouldn't be building a solar-powered device...

Pull the solar cell wires out towards the motor, and firmly stick the solar cell to the SolarSpeeder. You're done!

Now go find a nice sunny patch on the kitchen floor, and take aim at Fluffy. Cats like pouncing on these, especially if there's more than one to chase!

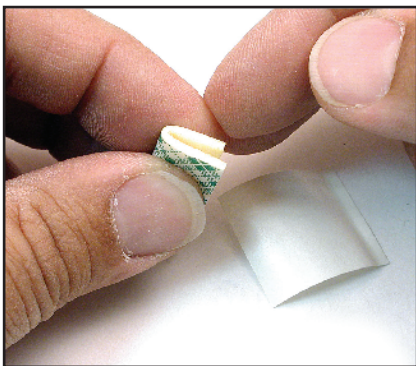

Peel off one side of the tape, and fold it in half.

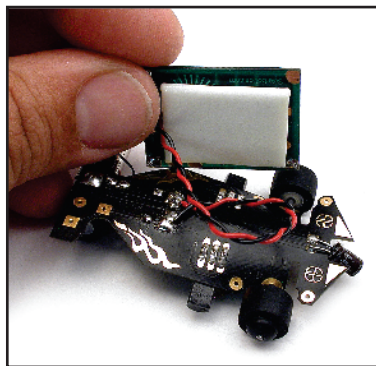

Peel off the other side, and stick it to the solar cell, away from the wires.

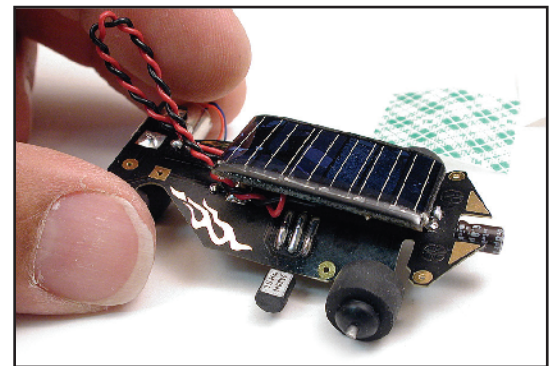

Pull the wires out of the way, and stick the solar cell down to the SolarSpeeder. Go racing!

Running, Tuning and Upgrading

Running your SolarSpeeder

Your SolarSpeeder is a very quick solar-powered device, but you have to wait a bit for it to charge. We find that in direct sunlight, it needs a solid minute for the first charge. After that, it's only about 15 seconds between runs!

When the SolarSpeeder motor is on, it runs for nearly 3 seconds, which is plenty of time for it to go almost 10 feet. The time the motor spends turned on is set by the C2 capacitor. You can make it larger, (say, to 22 μ F) if you want your SolarSpeeder to zoom a huge distance, but the recharge time will be suitably larger too. We find the 6.8 μ F capacitor is a good compromise between charging time versus running time, but feel free to experiment! Just remember that putting a HUGE timer capacitor (say, 1000 μ F) will keep the MCP112 on, even after there's no charge left in the power storage capacitor, which would be like stepping on the pedal when there's no gas left in the tank of your car.

There's not much you can do to tune your SolarSpeeder, as we think we've done a pretty good job of making it as good as it can be (but hey, prove us wrong!). Try using some light machine oil to keep the front two wheels spinning smoothly. Sewing machine oil is good, 3-in-1 oil is a bit thick. Or try graphite powder. It's black and a bit messy, but worth trying. Also make sure nothing is rubbing on the frame or wheels. Any little bit of rubbing will suck a lot of performance out of the SolarSpeeder.

You should notice that there's a set of pads near the motor that we haven't used for anything. Besides looking good, you can wire in a standard toggle switch to manually turn on your SolarSpeeder. We call these "impatience switches" for obvious reasons. They're also good for troubleshooting. Cross a wire (or anything metallic) from either of the square pads to the round one, and it will force the motor to turn on. If you use a real switch, be aware that it won't automatically reset and recharge. You have to turn the switch back off for the SolarSpeeder to start recharging.

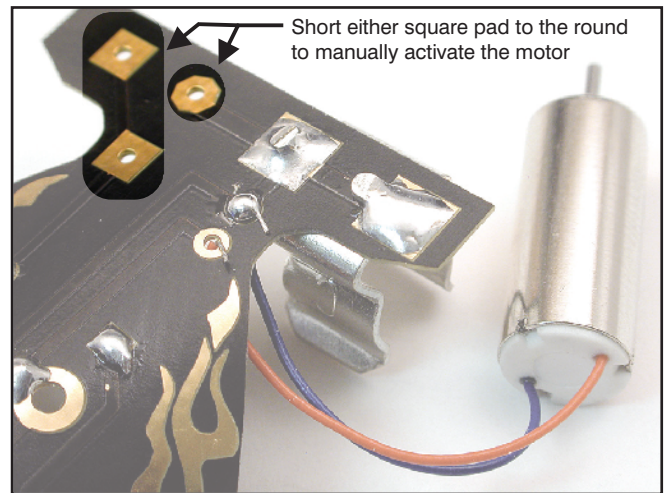

Further upgrades you may want to try include changing the power storage capacitor (or adding one to it on top, under the solar cell). The 1.0F capacitor will make it go three times further, but will take 3 times longer to charge. Oh, you'll also have to increase the size of the C2 timer capacitor to take advantage of all this new stored power - increase it to 22 μ F or more.

A bigger solar cell will charge it quicker, but it will be a bit heavier, so it may not travel quite as far. There's lots of room for experimentation! See what combination you like best!

Questions & Answers

Since your SolarSpeeder uses a relatively simple circuit, there are only a few things that can go wrong. Go through this list to see if any of these answers fix your problems:

“It doesn’t work at all!”: Start with the simplest things first:

- ▶ Does your SolarSpeeder roll smoothly? Is the rear motor wheel rubbing the motor mount?
- ▶ Is the solar cell connected from its ‘+’ to ‘+’ on the PCB? Same for ‘-’?
- ▶ Is the power storage capacitor installed the correct way?
- ▶ Is the MCP112 and transistor installed so you can see the flat face when the SolarSpeeder is sitting with the solar cell side upward?
- ▶ Are there any solder bridges between the pads of the 1381 or the transistor?
A bridge looks like some molten solder connecting two pads that are side-by-side. These are fixed by reheating the bad connections and pushing the solder out of the way.
- ▶ Do a “wiggle” test on all the soldered parts. This means firmly gripping the part, and giving it a little wiggle, while looking at the other side where the legs poke through the PCB.

If you see any of the legs moving, that means the leg wasn’t soldered in well enough. Get out the soldering iron, and add more solder to the connection!

“It isn’t going very far...”: Double-check the diode to make sure it’s in the right way around. If it is installed backwards, it will still work, but not very well. A backwards diode will let the timer capacitor only charge to about 0.7V, and will leak the power away quite quickly during a burst.

“Why do some go farther than others?”: The people who make the power storage capacitor (the 0.35F) say that they guarantee that it will store 0.35 farads of energy, plus 100%, minus 50%.



Final Notes

Had fun with your SolarSpeeder? We had a blast developing it! Although it wouldn't be a good competitor at the real "Solaroller" contest (it goes way too far and takes too long to charge to be competitive), you may want to try hand-building your own 1-meter racer. Here are the basic rules:

- Maximum solarcell area of 8.06 cm^2 (1.25 inches²). Your SolarSpeeder's solarcell is 7.68 cm^2 (1.19 inches²), 95% of the maximum allowed. Note: the cell size may change shortly!
- The Solaroller must fit in a cube measuring 15.24cm a side (6 inch cube).
- The track is 1 meter long (3.3 feet) with two lanes separated by a lane wall 2.5cm (1inch) tall, with a 15.24cm (6 inch) starting and finishing square at each end for each lane.
- The Solaroller must have shorting wires coming out from it that can cross a shorting bar that is placed at the back of the starting square. This ensures the competitors are fully discharged until the moment the race begins when the shorting bar is removed.
- Light is guaranteed to be a minimum of one 500 Watt halogen lamp placed 50cm (19.7 inches) above the race platform (often there is much more light).
- Devices must conform to a 2 second stationary rule which means the solaroller cannot move for a full two seconds after the race has begun. This is to ensure some sort of electronics have been implemented rather than NASA-quality solarcells connected directly to ultra-precision motors (it's been done!).

Solarbotics has developed our own Solar racecar event - the Solarbotics SolarSpeeder 100!

- Get a regular 8' x 4' smooth surface (like wall-board).
- Take some wood or books and make a barrier on one of the 4' sides.
- Create a 100mm (~4") gap in the barrier near the middle.
- Go to the other end of the surface, and aim your SolarSpeeder at the gap.
- If you don't get it through, measure how far from the middle you hit. Try it again!
- If you get real good, try adding a ramp!

Solarbotics usually runs a "SolarSpeeder 100" event at the robot games we attend. Bring your SolarSpeeder out to one, enter for free, and have a chance at some great Solarbotics prizes!

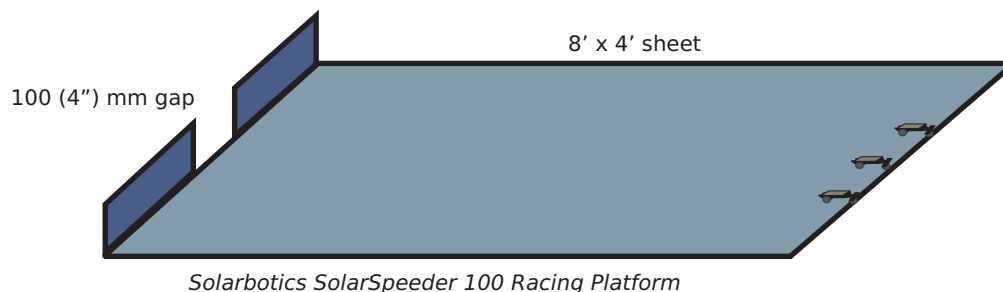

The **Solarbotics SolarSpeeder 2.0** is a high-performance Solar race-car. Using simple and efficient electronics to store up solar energy, it releases it in bursts of power shooting it over 3 meters (10 feet) at a time, once a minute in direct sunlight!

It's 30% faster than the original SolarSpeeder!

The SolarSpeeder was designed using ideas gathered from many years of Solaroller racing at the BEAM Robot games. You only need a soldering iron and basic hand tools to turn this high-quality coreless DC motor, lightweight body, and tweaked electronics to build your solar speed-demon!

Other Cool Projects from Solarbotics

Build some friends to keep your SolarSpeeder company!

Like the Mousebot, the *K PP Photopopper* seeks light and avoids obstacles but is solar powered! It's pretty quick, covering a meter per minute (that's 3.3 feet!). Newly upgraded with better electronics and gold circuit board!

K PP Photopopper \$35.95USD

Herbie the Mousebot is a 9-volt battery-powered robot that loves to chase flash light beams. If there are several Herbies in the same area, they can be configured to chase each other! These little robots are so quick, you have to run to keep up to them!

K HM Herbie the Mousebot \$39.95USD

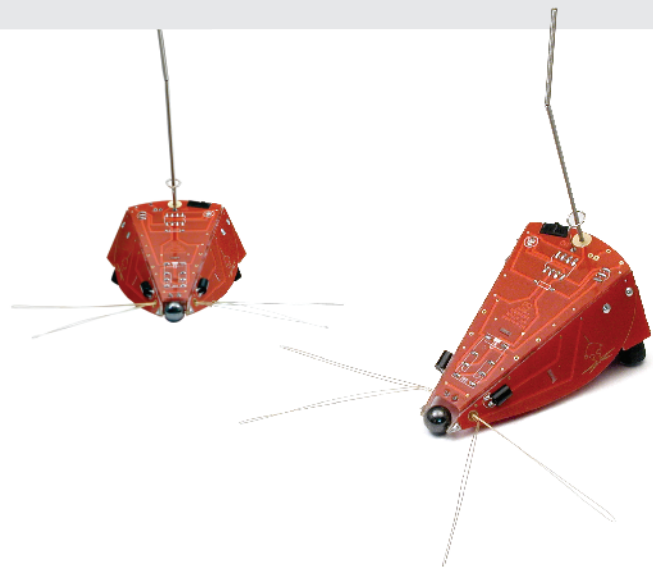
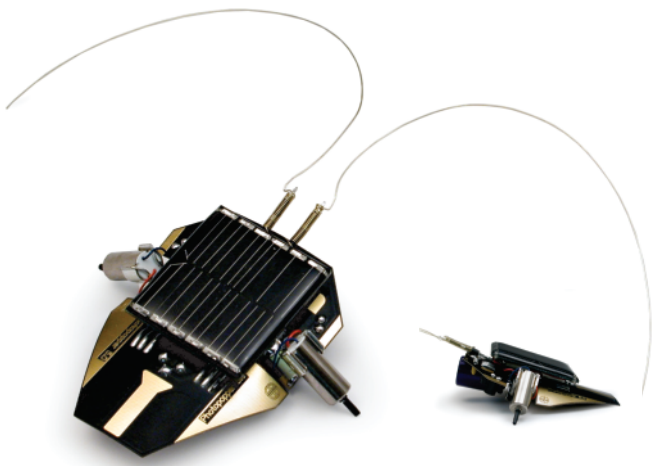

Visit us online for more info and cool stuff:

www.solarbotics.com

Solarbotics Ltd.
#101, 3740D - 11A Street NE
Calgary, Alberta T2E 6M6
Canada

Toll Free: 1-866-276-2687
International: +1 (403) 232-6268
Fax: +1 (403) 226-3741