

# The **SOLARBOTICS**<sup>®</sup> MSE Solar Engine Kit

## Rapid Fire SCC2433b-MSE Version

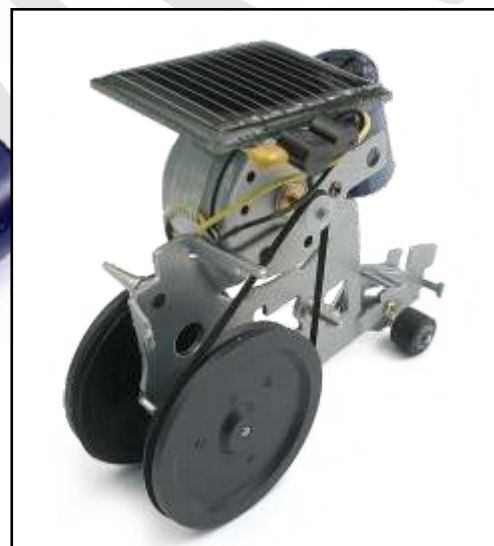

For true DIY, hack the included cassette mechanism into a solar-powered device using the high performance Miller Solarengine which converts light into rapid bursts of energy!

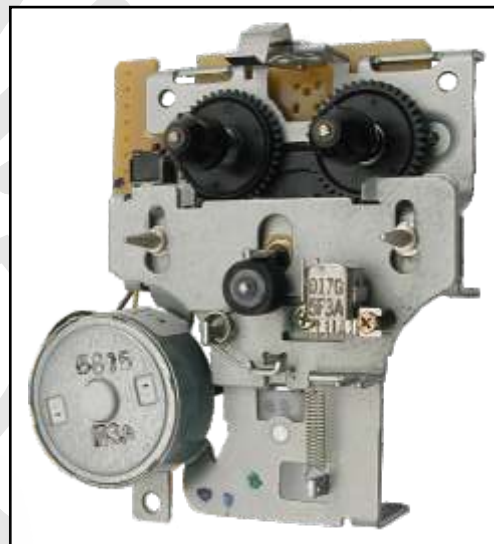
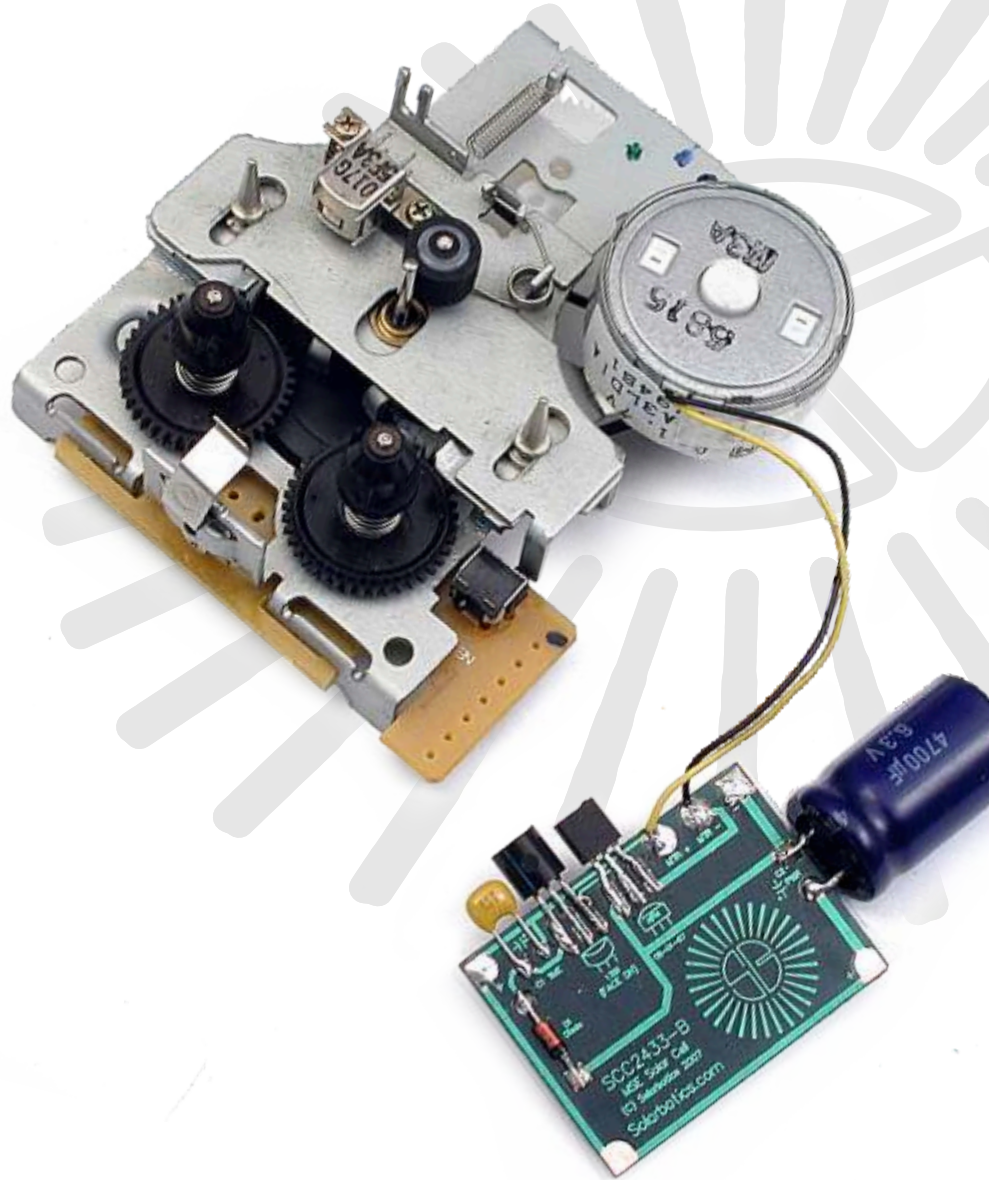

Skill Level:  
Beginner  
(Soldering Req'd)



# Table of Contents

<b>Introduction . . . . .</b>	<b>1</b>
<b>Parts Overview . . . . .</b>	<b>2</b>
<b>Solarengine Theory . . . . .</b>	<b>3</b>
<b>Essential Skills of Soldering . . . . .</b>	<b>4</b>
<b>Building It! (PCB Construction) . . . . .</b>	<b>5</b>
<b>Free Form Miller Solarengine. . . . .</b>	<b>7</b>
<b>Trouble Shooting . . . . .</b>	<b>8</b>
<b>Lets Get Moving! . . . . .</b>	<b>9</b>
<b>Techniques. . . . .</b>	<b>10</b>
<b>Another Hint Box. . . . .</b>	<b>10</b>
<b>Ideas for your Solarengine . . . . .</b>	<b>11</b>
<b>Ideas - The Photovore Light-Seeking Robot! . . . . .</b>	<b>12</b>
<b>Ideas - The CassetteMech Solaroller! . . . . .</b>	<b>13</b>
<b>Racing - Solaroller Rules . . . . .</b>	<b>14</b>

We strongly suggest you inventory the parts in your kit to make sure you have all the parts listed. If anything is missing, contact Solarbotics Ltd. for replacement parts information.

## Disclaimer of Liability

Solarbotics Ltd. is not responsible for any special, incidental, or consequential damages resulting from any breach of warranty, or under any legal theory, including lost profits, downtime, good-will, damage to or replacement of equipment or property, and any costs or recovering of any material or goods associated with the assembly or use of this product. Solarbotics Ltd reserves the right to make substitutions and changes to this product without prior notice.

# Introduction

First off, you should know that BEAM Robotics is a research and education organization dedicated to the promotion and construction of unorthodox robots and gizmos for fun and real world applications. This kit is designed as an entertaining and easy starting point for those who wish to explore the principles of BEAM philosophy.

The components in this kit are the bare necessities for achieving mechanical movement from the universe's most common energy source - **LIGHT**. This means no dependency on batteries, adaptors, wind up springs, or even *you* for it to continue "living" its merry life. With careful and sturdy construction, you should be able to pick up your BEAM critter in 20 years and say "Look! It's still working!" This kit is the Type-I solarengine, which depends on a voltage-sensitive trigger, meaning once it stores enough power, it triggers. The other types of solarengines are time interval based (Type-II), and "charge-curve differentiated" (Type-III).

Once the kit's electronics are assembled, you can move on to find applications for your solarengine, like a solar dragster (solaroller), a bidirectional robot (SYMET), or anything else you'd like to apply battery-less motion to. Advanced applications of this kit include solar rope-climbers, high & long jumpers, aquavores & photovores (light-seeking robots). Other bizarre applications are solar-powered name-tags, flag-wavers, baby satellite dishes, and ornament turners. Go wild and find your own applications to add to this list.

Finishing this kit will mean that you have achieved several significant tasks:

- A basic understanding of transistors, resistors, capacitors, and solar cells
- Recognition of fundamental motor drive systems
- How to solder electronic components onto a printed circuit board (PCB)
- How to get your partner to hold components together while you burn their fingers with a soldering iron.

In other words, you should have fun assembling something that moves by itself while we try to sneak educational things into your head.

The kit should contain the following goodies:

- 1 - Motor/cassette mechanism
- 1 - PN2222 transistor (small black thingy with 3 leads)
- 1 - 1381 voltage detector (another slightly bigger black thingy with 3 leads)
- 1 - Diode (another tiny cylindrical thingy with a lead out of each end)
- 1 - C2 Power Storage Capacitor (4700 $\mu$ F electrolytic, looks like a small can with two leads)
- 1 - C1 Timer Capacitor (0.47 $\mu$ F, looks like tiny yellow candy with two leads - don't eat it!)
- 1 - 24x33mm Solar Cell (the rectangularish solar-cell looking-thing, with circuit panel on backside)
- 1 - Length of wire to hook up the motor (if your motor doesn't have wire already)
- 1 - Instruction book (well, of course, right?)

You will require:

- A soldering iron & *electronics* solder (not plumbing solder)
- A pair of snips, old scissors, or other metal-trimming device
- A pair of safety glasses
- Glue, be it from a hot-glue gun, epoxy, Superglue, or whatever
- A sense of humour. Otherwise, you'll be finding this manual *very strange*.

## Parts Overview

This is the part you've probably skipped over unless either you've already got your circuit working and want to know more about why, **or** you're waiting for a bus to pick you up and take you to work/school (please don't read this while driving). Whatever your reason, here's the poop:

The circuit is made of five types of electronic components, of which the first three make up a good 80% of what you will find in almost any electronic device. These are:



**Resistors -** These are devices that "resist" the flow of electric current. Think of them like a narrow neck in a river. But we won't be using one in this circuit - heh!



**Capacitors -** Capacitor acts much like a small rechargeable battery, except that they charge and discharge much more efficiently. Think of these like water tanks on the side of the river that can be filled then emptied back into the river.

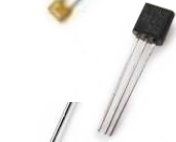

**Transistors -** Transistors are essentially switches that use a tiny amount of current to control the flow of a much larger current. These are like dam floodgates on a river.



**Diode -** This is like a one-way check valve, allowing current to flow through it in one direction only.



**1381 -** The 1381 voltage trigger is a small three pin integrated chip (IC) that looks much like a transistor. It was originally designed to detect low voltage levels in the batteries of portable electronic devices, like cellular telephones and portable computers. These take very little power to monitor the voltage, making it much more efficient than older trigger devices like zener diodes or flashing LEDs.



**Solar Cell -** Solar cells are very thin specialized chips that convert the photons impinging the PN junction into electrical current. Translation: The thingy that turns light into electricity. Usually the bigger, the better.

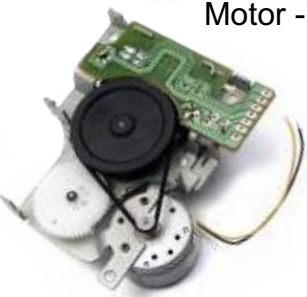

**Motor -** The motor you'll be using in this kit is from a *micro-cassette player*. This mechanical assembly was originally designed to be used in an answering machine, but you're going to use it for the motor and other mechanical bits you may want to rip off it. A motor is simply a way to turn electrical energy into mechanical motion we can see and use.

# Solarengine Theory

The Miller Solarengine (MSE) is a simple, effective Type-1 (voltage triggered) solarengine with configurable turn-on voltage and discharge time. The turn-on voltage is determined by the type of 1381 selected, and the discharge time configured by the size of capacitor C1.

While the solarcell charges the capacitor, its status is monitored by the 1381. When a preset voltage is reached, the 1381 turns on the PN2222 transistor, which pulls power through the motor, making the motor turn. R1 is presently a zero ohm resistor - the same thing as a piece of wire. You can change R1 to something else if you are planning on driving components other than a motor, like a LED, or another electronic circuit. Raising R1 will make the circuit stay on longer, but it won't pass as much power.

The 1381 stays on as long as it thinks there is sufficient voltage between its trigger value and (trigger voltage - 0.3V) i.e.: 2.7V down to 2.4V (for the 1381E). To extend how long it stays on, we use capacitor C1 and a diode. C1 gets charged up through the diode at the same time as the solarengine main storage capacitor C2, but discharges much slower through the 1381 voltage trigger to the transistor. We use the discharge time of C1 through the 1381 to set how long the circuit stays on.

Using a C1 of  $0.47\mu\text{F}$ , we get a discharge time of approximately 1/5 of a second while powering the motor out of a micro-cassette mechanism. If you want, you can put in a smaller C1 to get more frequent, high-power bursts, or a larger ( $1.0\mu\text{F}$ ) for longer bursts, but the default  $0.47\mu\text{F}$  capacitor is practically ideal for the components in this kit.

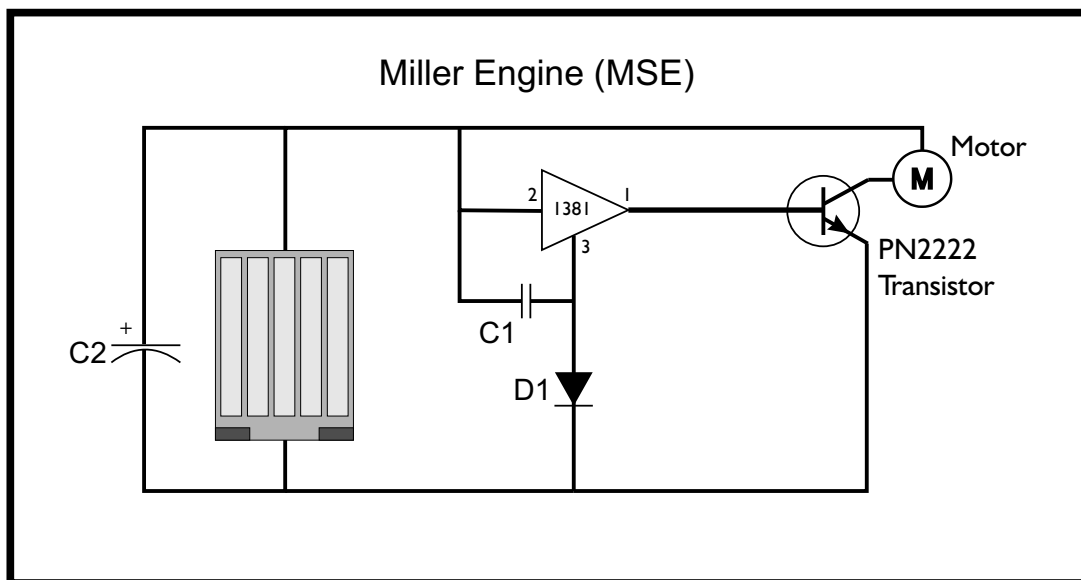

Change this:	Motor Time On:	Time to Recharge:	Result:
Larger C1 Storage Cap	Same	Same	Longer initial charge-up, quick, high-energy bursts. This is because C2 sets how long it stays on for. Make C2 larger to increase how long it stays on for when increasing C1.
Larger Solarcell	Same	Quicker	Quicker initial charge-up and recharge times.
Larger C2 Timer Cap	Longer	Longer	The motors stays on longer, which pulls more power out of the capacitor. This takes longer to recharge, but gives a longer motor pulse.
Smaller C2 Timer Cap	Shorter	Shorter	This will result in quick, high-energy bursts, but won't spin the motor for as long.
Higher 1381 Trigger	Same	Longer	The 1381 sets at what voltage the circuit activates. If it gets too high, it gets harder for the solarcell to charge the

## Soldering - The Essentials:

The most important skill needed to successfully construct your device is soldering. Soldering is melting a special metal (called, um..., "solder") between two components to make an electrical connection. We can also use solder like glue, to build things out of metals. You must make sure to use *electrical* solder, and not plumbers solder, which is used for piping and really isn't good for electronics.

Much like you, solder likes to go where it's the warmest (this is why Florida is so popular). The trick to successful soldering is to make the *parts* hot, and the melting solder will run there. If you don't heat up the parts first, the solder will find the hottest thing around - your soldering iron, and not your parts! Do *not* melt solder to the tip of your iron and try to smear it onto the parts, as it just won't work. You're a roboticist, not a painter!

Here's how to successfully solder to your MSE-style solar cell circuit board. It doesn't have holes to poke the parts into, so we're going to pre-tin (pre-apply solder) to the circuit-board pads.

- 1) Wipe the hot tip of the soldering iron on a wet sponge each time, to clean it.
- 2) Melt some solder to the set of pads you want to solder something too, leaving a little mound on the pad.
- 3) Melt a little solder to the legs of the component (very little needed).
- 4) Place the part on top of the pads, and re-melt the part *into* the mound on the pad by pressing on the leg with the hot soldering iron tip.
- 5) DON'T Rush - electronics are hard to burn up!



1. Presolder the pads...



2. ...so it looks like this!

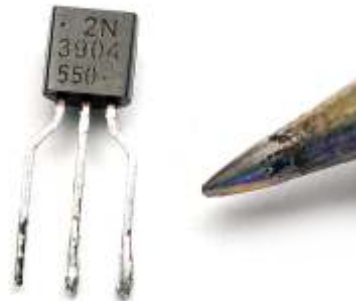

3. Presolder the component leads too.

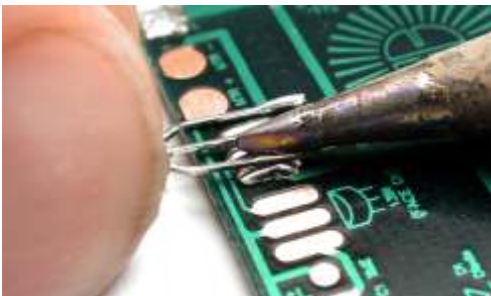

4. Push the lead into the pad...

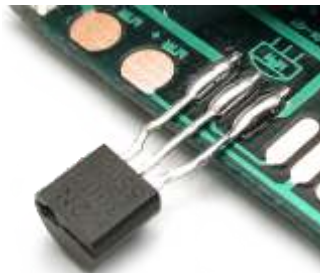

5. ...so it looks like this!

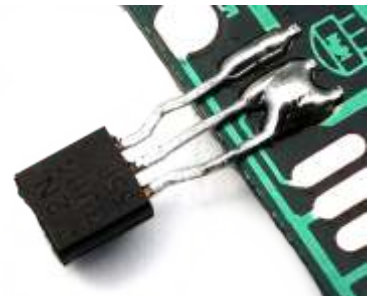

6. Yuck! Don't bridge pads!

# Building It!

This is the fun part - actually building the circuit. Follow the instruction boxes in order, and you will turn these parts into your own functioning Miller Solarengine!

## Construction Hints:

- If you have NEVER soldered before, hunt down the “How To Solder” instructions in this book first!
- Since we’re soldering directly on the circuit board (no holes), you will find it is easier to add some solder to each pad first, then remelt it when adding the part.
- Fold, fit, and pre-trim the leads of each part before soldering. It’s much easier than trying to force it to fit on-the-go!

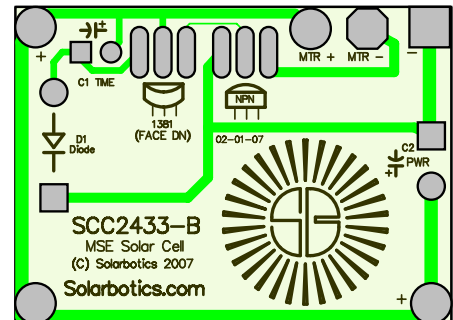

## Step 1: 2n2222 Transistor

The transistor is the part that actually switches the power on so the load (motor, LED, whatever...) receives power. Solder it in face up!

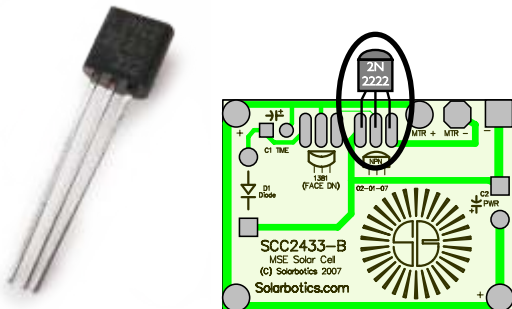

## Step 2: 1381 Trigger

The 1381 watches the voltage stored in the power capacitor, and turns the circuit at the voltage level determined by what “flavour” of 1381 you’re using (C/E/G...). Make sure it’s installed FACE DOWN!

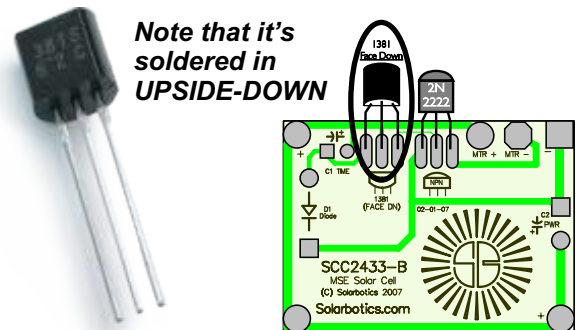

## Step 3: C1 Timer Capacitor

C1 tricks the 1381 into staying on longer than it should, so it acts as a time-setting device for how long the Miller Solar Engine will stay activated for. The higher the value, the longer you dump power!

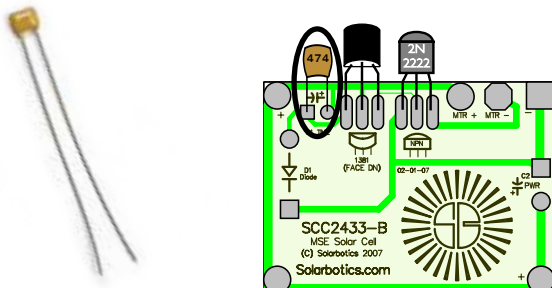

## Step 4: D1 Diode

The diode keeps the power in the C1 capacitor from going anywhere *but* the 1381. Get it in backwards, and you’ll definitely have a malfunctioning circuit!

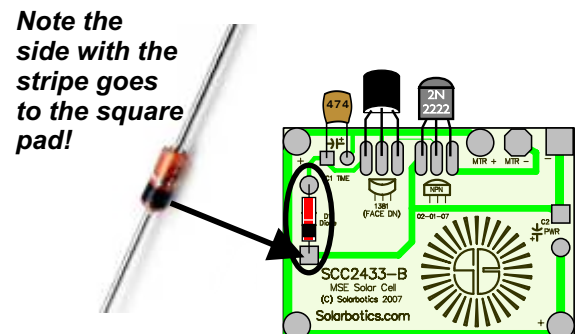

## Step 5: C2 Power Capacitor

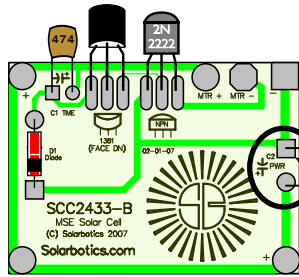

**Note the side with the stripe goes to the square pad!**

C2 is what actually stores the power for the load to use up. A small capacitor charges much quicker than a super-capacitor, and gives frequent pulses.

Remember: Backwards caps don't charge well!

## Step 7: Testing!

Now the fun part - watching it go! Put your device in light, like sunlight or under a 100 watt incandescent or halogen bulb (fluorescents and flashlights will give disappointing results).

With the 4700 $\mu$ F power storage capacitor, you'll see motion almost immediately - every few seconds at most.

In very intense light you may even see continuous motion!

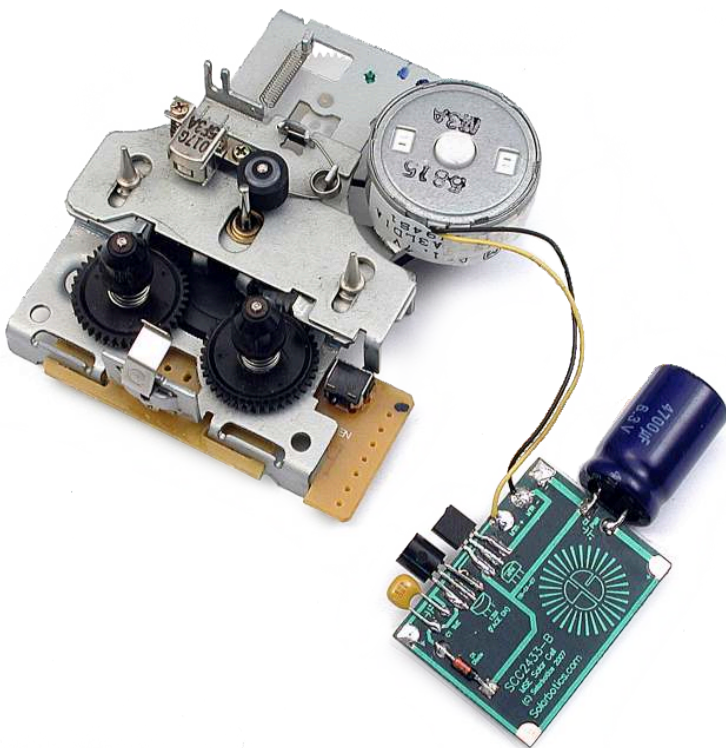

## Step 6: Motor / Load

The load can be any electrical device that doesn't draw too much power. If you were to try to start your car with this circuit, you'd be very disappointed! As long as what you're trying to power *used* to be battery-powered from AA cells, this circuit should make it twitch.

That means you can use things like LEDs, solenoids and even coils (put a magnet over the coil to see it jump). Of course, the more power-efficient the load is, the more "bang for your buck" you'll get!

**Don't worry about wire colors - if the motor spins in the wrong direction, just reverse the connection!**

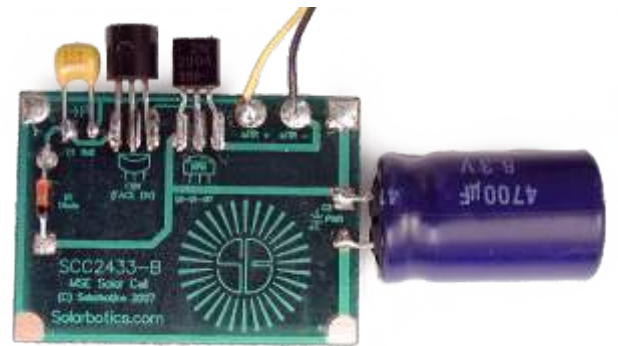
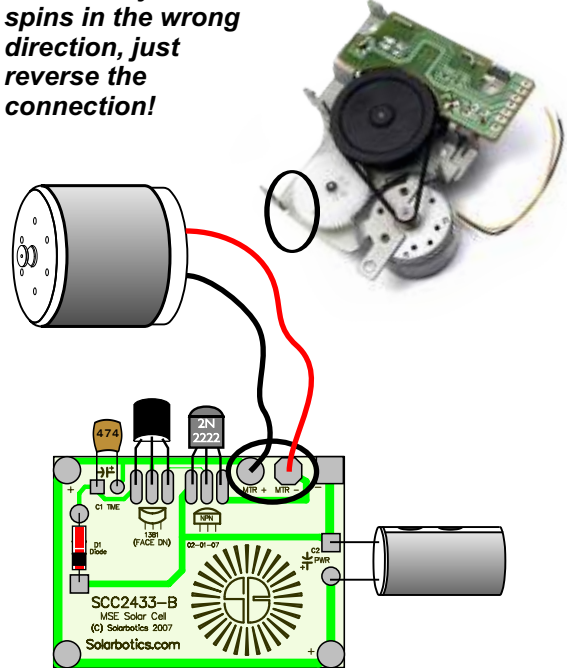



# The Free-Form Miller Solarengine

Find a solar cell without the circuit board on it?  
Build your own "free-form" version!

You will need a PN2222 transistor, a diode, a 1381 trigger (C or E), a storage capacitor (1000 $\mu$ F or higher), a timing capacitor (0.47 $\mu$ F to 10 $\mu$ F), wire, a motor and a solarcell (solarcell must generate 3.2V MINIMUM).

(And it's all fit onto one easy-to-read single instruction page!)

## 1 PN2222 Transistor

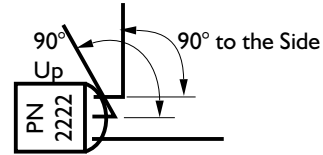

Bend the right side lead (the *collector*) 90° to the side.

Bend the middle lead (the *base*) 90° up, so it points up at you.

## 2 1381 Voltage Trigger

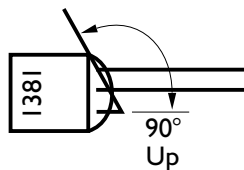

Bend the left side lead (the *output*) 90° up so it points towards you.

## 3 1381/PN2222/Diode

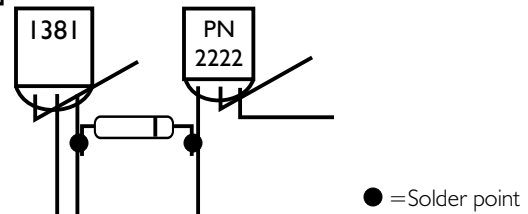

Place the 1381 and PN2222 transistor side-by-side, and join the inner legs with the diode as shown. Note that the black band of the diode is on the RIGHT side.

## 4 Wire

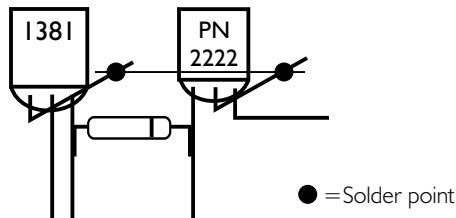

Bridge the vertical legs of the 1381 & the PN2222 with a wire, then cut off the excess leads. If you can bend & solder the legs together, you won't need a wire at all.

## 5 Timer Capacitor

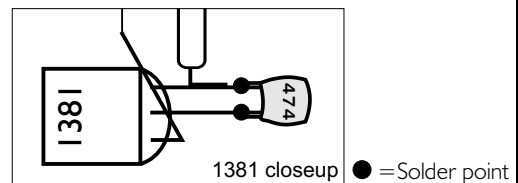

Mount the desired discharge timer capacitor (in this case, 0.47 $\mu$ F) across the middle and right legs of the 1381. If the capacitor has polarity, connect positive (+) to the middle leg of the 1381.

## 6 Main Storage Capacitor

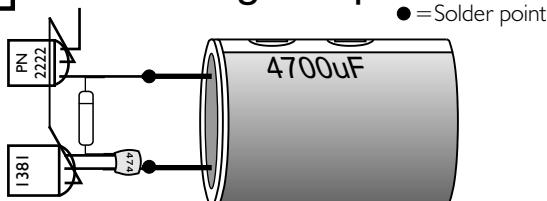

Solder the main capacitor so the capacitor leg *nearest the stripe* on the capacitor body (-) is soldered to the left leg of the PN2222, and the other leg (+) is soldered to the middle leg of the 1381.

## 7 Final Assembly

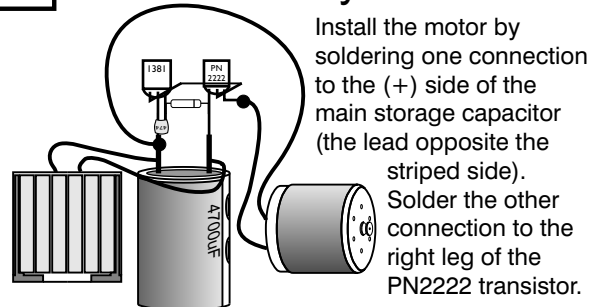

Install the motor by soldering one connection to the (+) side of the main storage capacitor (the lead opposite the striped side). Solder the other connection to the right leg of the PN2222 transistor.

# Trouble Shooting

Well, you take yer six-shooter, line up the troublesome BEAM critter on a wooden fencepost and... aw, it's really not that hard to fix this circuit. There isn't much that can go wrong with this particular layout. Run through this checklist and see if you can isolate your problem. If you're still stumped after this, leave it for a day and come back when your sanity returns.

## Problem:

- 1381/transistor/diode installed the wrong way around
- Backwards polarity on the capacitor
- Solder Bridge (solder crosses copper pads on PCB)

## Remedy:

- Make sure the part is installed in the spaced marked for it - there's not that many parts to get mixed up!
- **BOTH** capacitors are polarity sensitive, meaning they have to be installed the right-way around. Striped side *always* is the '-' side.
- Carefully examine the PCB to see if any solder hasn't accidentally "bridged" from one pad to another. Remove any bridges by melting it with the soldering iron and then sharply tapping the PCB against a hard surface.

Another valuable diagnostic tool is a voltmeter. If you have one available, connect it to the capacitor leads. Voltage in the capacitor should climb to about 2.6 before it dumps the power to the motor.

Be sure that none of the existing component leads are accidentally pressing against any other leads or PCB traces. The traces that make the electrical connections are usually protected by the green or black plastic covering on the back of the solar cell, but it *can* be scraped off (making a short circuit, which is bad!).

Push come to shove, call us - but **NOT** in the middle of the night. The circuit's not designed to operate at night anyway (yeah, yeah - *that's* the reason...). Or use your digital camera on "Macro" mode (usually a setting with a flower symbol) to take a clear picture, and email it to us.

## Let's Get Moving!

The fact that you're reading this means you have a working solarengine (or you're bored and just filling time until the TV commercials pass to the next program). This section is designed to help you get something moving across your desk/floor/sibling/significant other. All the following locomotion ideas are well tested in existing BEAM machines, with some working better than others in different situations. We suggest that you try the SYMET idea first as it is simple and effective, but do try the others for comparison. And don't hesitate trying to combine them.

### "SYMET" Direct Drive

By placing the motor on its face and tilting it just a little, it will move in one direction. Watch a toy top roll to a stop, and you'll recognize the motion in the SYMET drive. The term "SYMET" comes from "symmetrical", which is useful for robots that reverse direction when they bump into something. See if you can come up with a method of making the robot tilt from one side to the other so it changes direction. This system is simple and effective, but also results in robots that don't usually go very straight - ok for photovores, but bad for solarollers.

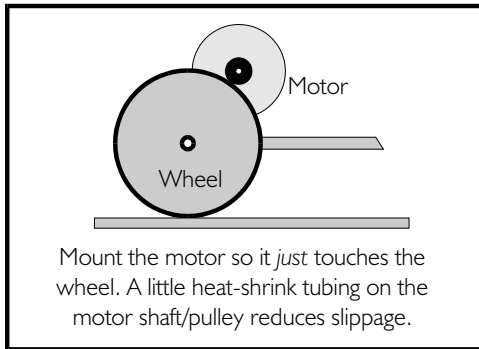
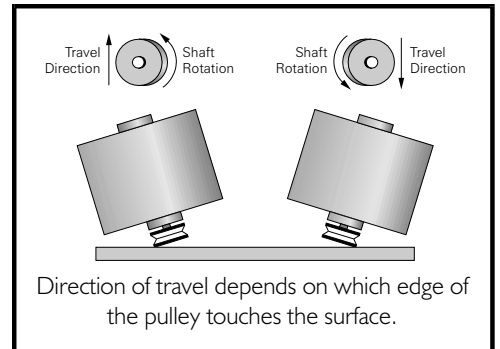

### Friction Drive

By removing the pulley and placing the shaft of the motor right up against a wheel, you can motivate your BEAMbot with a friction system. This arrangement results in straighter-travelling BEAM critters, but reversing direction becomes a problem. Slippage between the shaft and the wheel becomes a concern, which can be fixed by increasing the force between the motor & wheel, or increasing the friction between the two with some heat-shrink electrical insulation on the motor shaft.

### Pulley Drive

This is what your average cassette deck uses, so you should have the parts readily available. You usually can cut the pulley drive right out of the system, motor included. If not, build your own, making sure to use the black belt from the cassette mechanism. Elastic bands stretch too much, and why not use the belt that's *designed* for this purpose? Be careful not to make the belt too tight - you'll simply be wasting power.

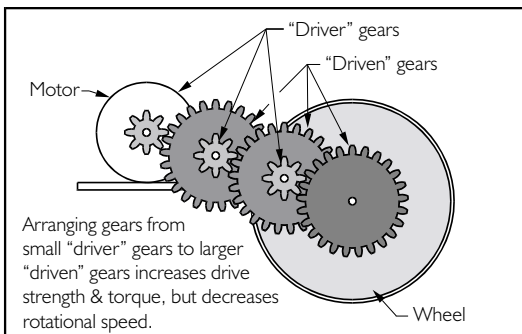
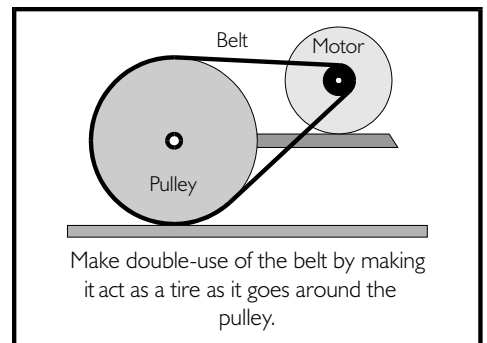

### Gear Drive

Most battery-powered devices have a gear-drive somewhere in them but it's often tough to find gears that match your motors and wheels. Rip a few things apart and you may get lucky. Try salvaging the whole geartrain instead of just prying the gears loose -it'll work better than trying to rebuild them yourself. Good places to start looking are in auto-reverse tape players and clock mechanisms.

# Techniques

Here are some techniques we've found that are valuable when starting off in BEAM robotics. Instead of taking you many hours of experimentation, we've put them all on this single page!

*Keep super-glues away from anything you plan to solder - it results in some nasty fumes when heated!*

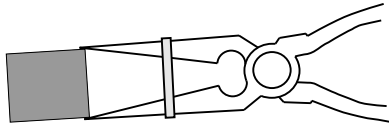

Put an elastic band around the jaws of your needle-nose pliers to hold parts while soldering. It saves you burning your fingers!

*Looking for a cheap & handy clamp to hold pieces together while you solder them? Look for a wood clothespin, and whittle it to the right shape needed to hold your parts.*



Paper clips can be a cheap source of solderable wire for making frames for your solarengine. Keep an eye out for the copper/brass type.

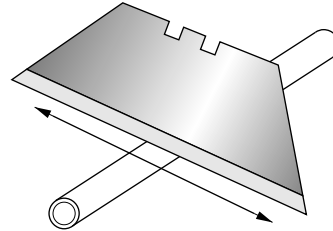

Brass tubing (commonly available at hobby shops) can be cut without crimping by rolling it with a razor blade. Dull blades work too.

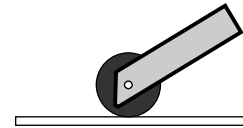

Rubber pinchrollers from cassette deck mechanisms make GREAT wheels for Solarollers!

Any shaft can be made bigger to fit gears/wheels/pulleys by using successive layers of plastic heat-shrink electrical insulation tubing.

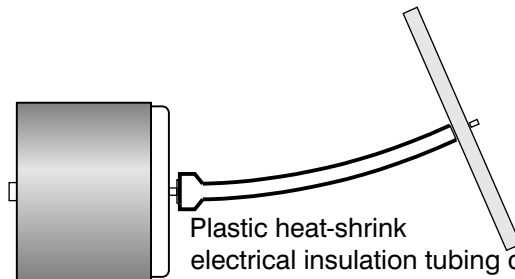
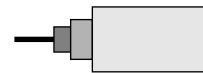

Plastic heat-shrink electrical insulation tubing can be used to make flexible drive shafts. Think of propellor shafts...

## Ideas for your Solarengine *The Symet, Roundabout & Solar Flag Waver!*

If you want to construct something other than a Solaroller, you may want to try one of these devices - the "Symet", the "Roundabout", or the "Solar Flag Waver".

The "Symet" is a simple robot that interacts with its environment by the use of tactile (touch) sensors. When one sensor hits an obstacle, it causes the Symet to tip over to the other side and scoot away in the opposite direction.

The Symet "Roundabout" is an easy implementation of the Solarengine with the addition of two paperclips. By soldering the paperclips to the bottom of the motor (as shown in the picture), the Roundabout will spin around in circles. This makes it more mobile than a Solar Flag Waver, but still keeps itself in a central location.

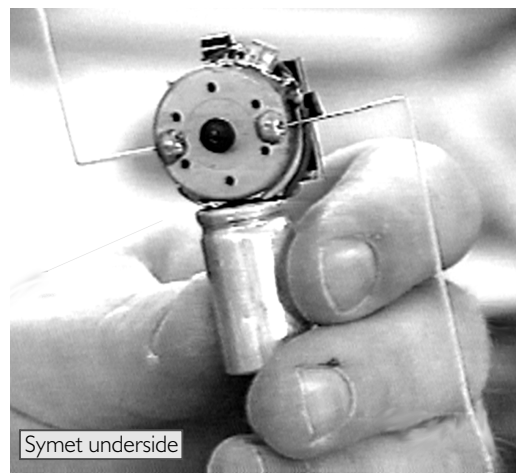
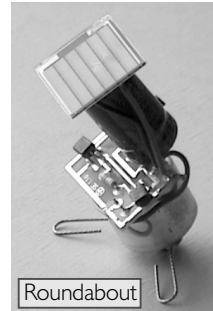

Another effective, simpler idea is the *Solar Flag Waver* (SFW). This BEAM critter won't sneak away from you and experience "Sudden De-acceleration Trauma" (that means "fall-down, go-boom!") like the Solaroller can. It is also neat to have on your windowsill where it happily sits, signalling its presence to the rest of the world with its occasional blip of movement. It has such interesting presence that there aren't many photovore worlds or Robot Jurassic Parks out there that don't have a selection of these "Robot Plant Life-forms."

It is very simple to turn an operational Solarengine into a SFW by simply adding some legs to the motor and adding a flag mast to the output shaft of the motor. Here's where raiding the junk drawer for older, copper/brass paperclips works well. Unbend one end of the paperclip and solder it to the top of the motor, like in the diagram. Just be sure to sand or file off a spot on the motor so it's shiny - this make soldering to the motor much, much easier. Glue the solar cell to the side of the SFW, mount a mast in place with glue or solder, and tape a business card or small sign to it and you're done!

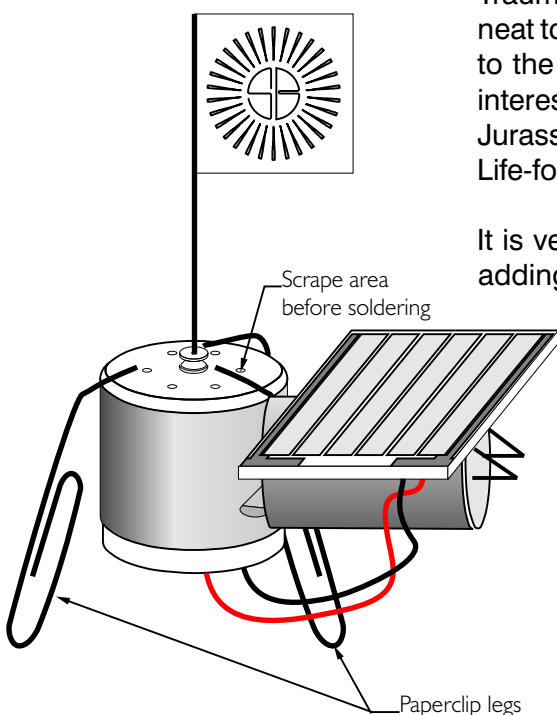

# Advanced Ideas for your Solarengine

## The Photovore Light-Seeking Robot!

Note: Ok, we cheated a *bit* - this is a Solar Engine project from a while back using a PCB instead of the new PCB-on-the-back system. But the principles remain the same, so stop being so picky!

The Solarengine lets you make some interesting solar-powered devices, especially ones that can survive in lower light levels with small solar cells. But to make something that is truly a robot with a built-in purpose-of-life, you have to build something that is able to track & chase it's food (light!). These are often called "Photovores", from the Greek & Latin meaning "Light-Eater".

This BEAM Photovore is such a creature. It's made from two separate solarollers mounted side-by-side in a "V"-shaped arrangement with a connecting crossbar, and with the solar cells facing inwards, towards each other.

When there is an uneven light falling on the Photovore, one solar cell gets more light than the other, making more active than its mate. This more-active solarengine will tend to turn the whole device towards the light until the light levels are about equal, and it will steadily move toward the light. This is called a behavior showing *positive phototropism*. You could arrange the solarengines so they make the robot scared of light (a Photophobe), but how much fun is it constantly picking your robot out from underneath the couch where the killer dust-bunnies live?

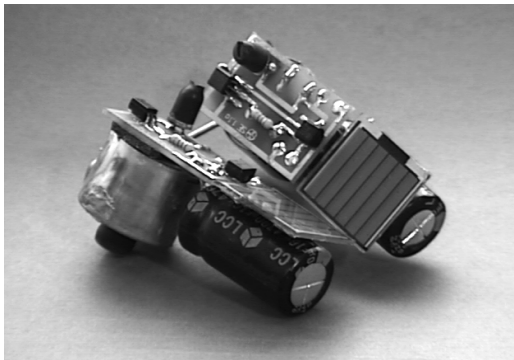

This particular Photovore is constructed entirely from the contents of *two* solarengine Kits and a piece of copper rod (the crossbar). The pinchrollers from the metal cassette mechanisms were cut apart so the rubber tire could be removed and stretched over the output shaft of the motor, giving the Photovore much better traction.

To add more survivability, you can add touch sensors to the front, one for each side, assigned to the opposite side's solarengine. Wire them so it shorts out the power storage capacitor. When the sensor is activated by an obstacle, it will make your Photovore pivot away from the obstacle until the switch comes free - instant obstacle avoidance!

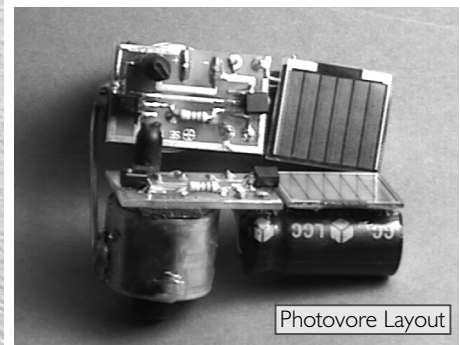
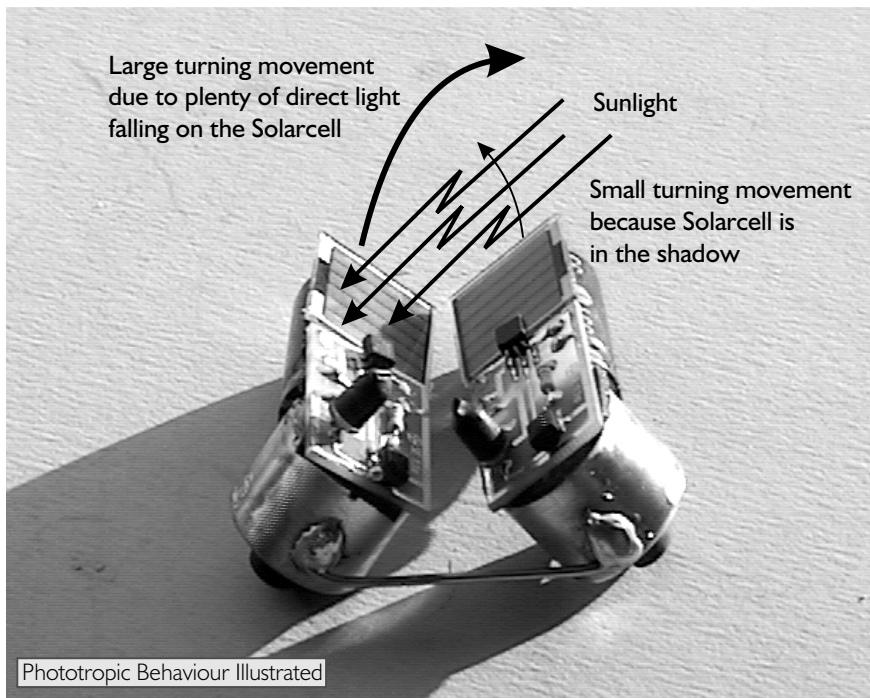

## Advanced Ideas for your Solarengine **The CassetteMech Solaroller**

It's sooo much fun turning junk into something brand new. One of the tasks around Solarbotics is to keep an eye out for cool technology we can do exactly that - turn it into something it wasn't! The CassetteMech Solaroller is one such Frankenstein-esque creation:

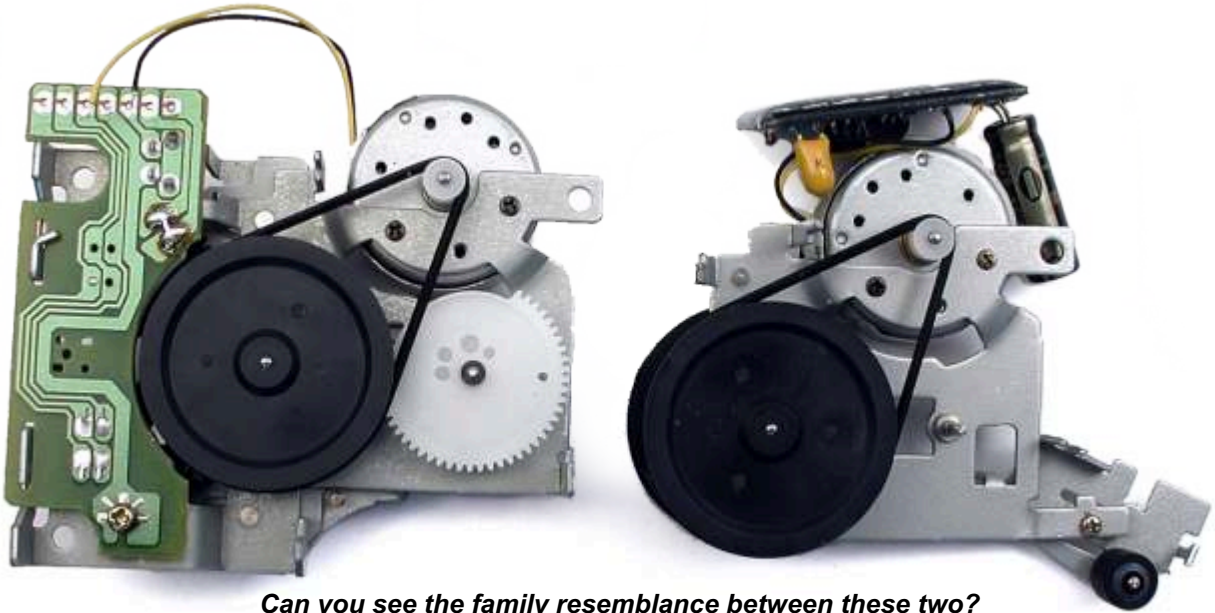

*Can you see the family resemblance between these two?*

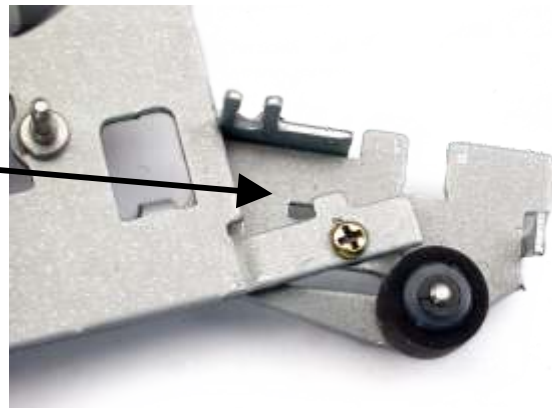

*Strip off the tape-reading head, yank the assembly and use a left-over screw to turn it into the front wheel!*



*Ok, ok - we cheated a little. We had a spare mechanism, and found that we could push a second black wheel onto the same shaft as the main black wheel. And BOY does this little Solaroller zoom!*

# Build your Device for Competition

## *The Official Solaroller Race Rules*

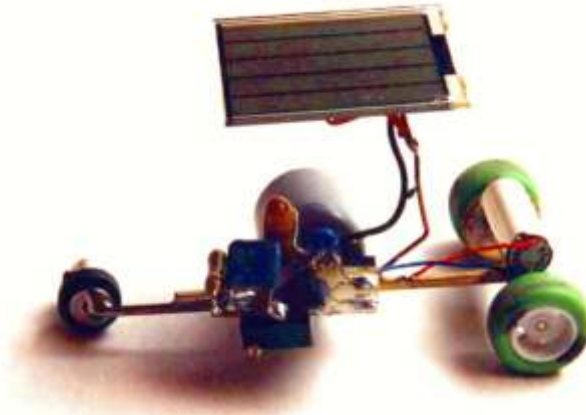

Fig 1: Solaroller "Scooter" (Dave Hrynkiw, 1995)

### **Object:**

Given a maximum solar cell size of  $806.5 \text{ mm}^2$  (1.25 square inches), make a self-starting 150mm (6") robot dragster to race one meter (3.3 feet) in full sunlight (or 1,000 watts Halogen lighting). Competitors will race each other down parallel 150mm (6") wide lanes. Fastest to finish, or furthest traveled in 3 minutes wins.

### **Competitor Design Parameters: Solaroller**

1 - At the start of the race, the competing Solarollers potential energy must be zero (0) volts. To insure this, Solarollers must have a pair of shorting wires extending from them far enough to reach a metal shorting bar at the rear of the 150mm (6") starting square. When these wires contact the shorting bar, it must clamp all on-board power storage to zero. Solarollers cannot use any other energy source to motivate them than what they are able to draw from their solar cell. No pre-tensioned springs, elastics, combustion or compressed energy sources are allowed, though any of these may be employed in the design so long as it can be proved that they are at a complete state of rest at the beginning of the run.

2 - Competitors cannot initially exceed the bounds of a 150mm (6") cube. Competitors may split apart or change their physical geometry beyond the dimensions of this cube during a run, but a win will only count when the LAST part of a shape-changing Solaroller has crossed the finish line. Competitors are not allowed to drop, throw or leave behind any part of their chassis. Competitors must finish with everything they started with.

3 - Competitors cannot have parts removed or added to them between races with the exception of replacing broken components necessary to the operation of the vehicle. The replacement parts must be identical to the part being replaced, and fact of this be shown to the judge.

4 - The maximum allowable solar cell surface area cannot exceed  $806.5 \text{ mm}^2$  (1.25 square inches). A 24x33mm, solarcell shall be considered the norm, except in the case of using a solar-walker, where a 37x33mm is considered the norm. Any solar-cell configuration will be considered valid so long as the effective cell area does not exceed the maximum allowable. Any solarcell not meeting this requirement will disqualify the device. There is no minimum solar cell size restriction.



# The Official Solaroller Race Rules

~ continued ~

5 - During racing, competitors must not physically touch or attempt to touch each other, however, competitors may attempt to interfere with each others light source by extending vanes or other devices over the 25mm (one inch) lane walls. Vane extensions must still fit within the size guidelines.

6 - Designers are not allowed to augment their competitor performance by the use of external light sources, or even subtle reflections off of watches or eyeglasses. Devices will be illuminated by a minimum light source of two 500 watt halogen lights placed 50cm (19.7") above the race platform, to a maximum of up to pure noon-time, unobstructed sunlight. In the case of halogen lighting, the first light is placed aimed straight down directly in front of the starting box. The second light is aimed straight down, 66cm (26") from the starting line.

7 - Competitors should be able to withstand heat excesses up to a radiant 50° C (122° F) from the competition light sources. Melting competitors will be disqualified.

## The Race:

The single-heat race begins when the judge says "go" and lets a charge build up in the two competitors. This is done by the judge lowering the conductive metal rail at the rear of the starting box that is shorting out the circuitry in the competing racers. Care shall be taken to insure that competitors are released fairly and with as little disturbance as possible. It is the competitor's responsibility to install suitable wires for this purpose.

Once the contacts are open and the devices allowed to charge, the race has started. To insure the devices follow the "self-starting" rule, competitors must remain immobile for at least three seconds following the start of the race. If one or both move within that time, a false start is called and the race is re-run. If the Solaroller again false-starts, it will be disqualified.

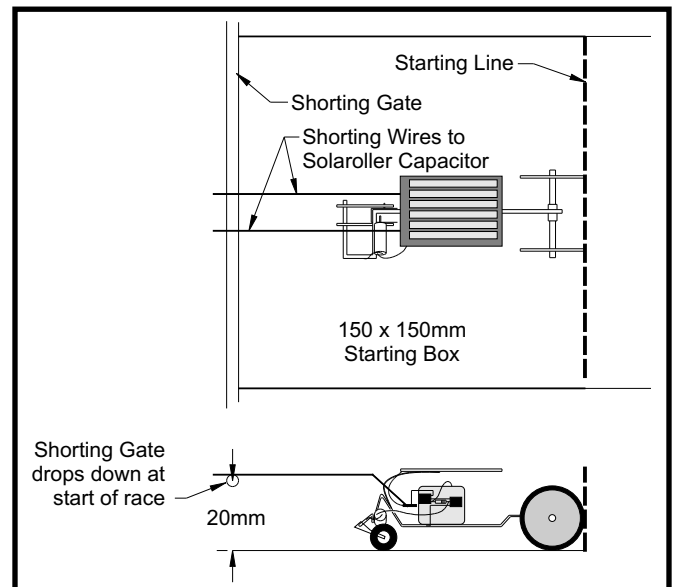

The race is run until the frontmost vertical edge of a competitor crosses the finish line at the end of the 1 meter lane, until a designer concedes, or until a full 3 minutes has elapsed (at which point the racer travelling furthest wins). The exception to this is when a Solaroller changes it's shape, and must fully cross the finish line.

During the run, competitors are allowed to touch the surrounding walls as necessary but should not damage or climb the walls. If a Solaroller becomes stalled against the wall, it cannot be interfered with. In the case of a dual stall, the furthest travelled competitor shall be considered the winner of that heat.

If clear, unobstructed sunlight is available or the halogen light option is used, the times of the individual runs will be kept track of. All running times shall be registered and recorded.

## **Closing Notes...**

We hope that you've found your Solarengine kit a fun & satisfying way into BEAM robotics - after all, that's what we wrote it for. But feel free to disregard our instructions and try your own techniques. Some of the world's best inventions came from people disregarding instruction manuals...except those same people still have no idea how to program their VCR.

We've been told that there should be a chapter on "Dumpster Diving 101 - how to salvage cool garbage and still maintain dignity." Well, it's an acquired skill, taking years of practice and dedication. Actually, it's as easy as keeping an eye peeled at work or while in the neighbour's garage. "Hey - you ever gonna use that broken walkman?" or "Mind if I take that trashed typewriter home with me tonight?" will take you far without ever having to manually dig through refuse (but that works too!). Also keep an eye open when you're at a second-hand or surplus store. What is junk or overstock to other people can be excellent BEAMbot material. Related to Dumpster Diving is the "Rip it Apart" ethic, which states:

- 1 - Always rip things COMPLETELY apart, and
- 2 - Never put them back together the same way.

You'll find the "Hey - that's cool!" factor goes waaaay up doing this.

Solarbotics Ltd.  
201 - 35th Avenue N.E.  
Calgary, Alberta, Canada, T2E 2K5  
(Mon-Fri, 9am-5:30pm MST)  
Ph Toll Free: 866-276-2687  
Fax: (403) 226-3741  
info@solarbotics.com  
www.solarbotics.com