

Photopopper Photovore

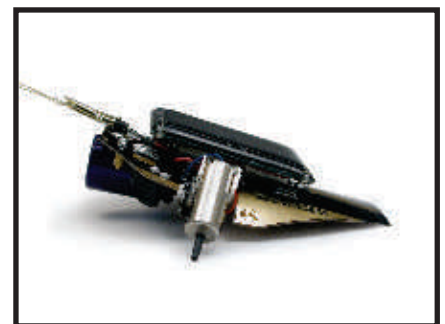

Unlike most robots, this BEAM robot is *solar-powered*, and does not have an off switch. Optical and touch sensors give the palm-sized Photopopper Photovore light-seeking and obstacle-avoiding behaviour. This robot doesn't use a microprocessor or computer "brain", making it straight-forward and easy to construct and tune!

Skill Level:

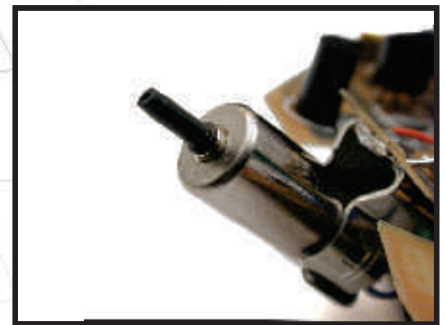
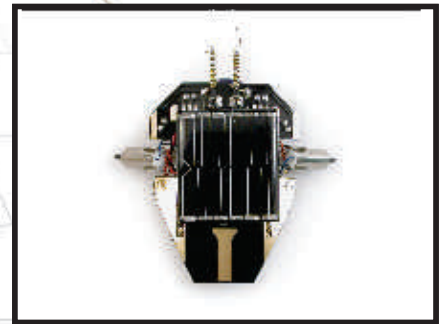
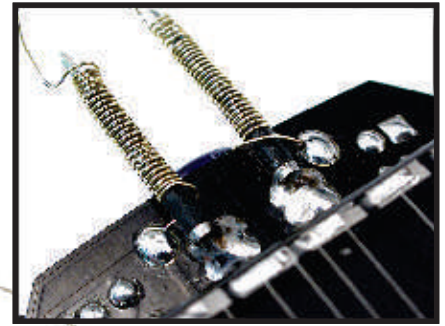
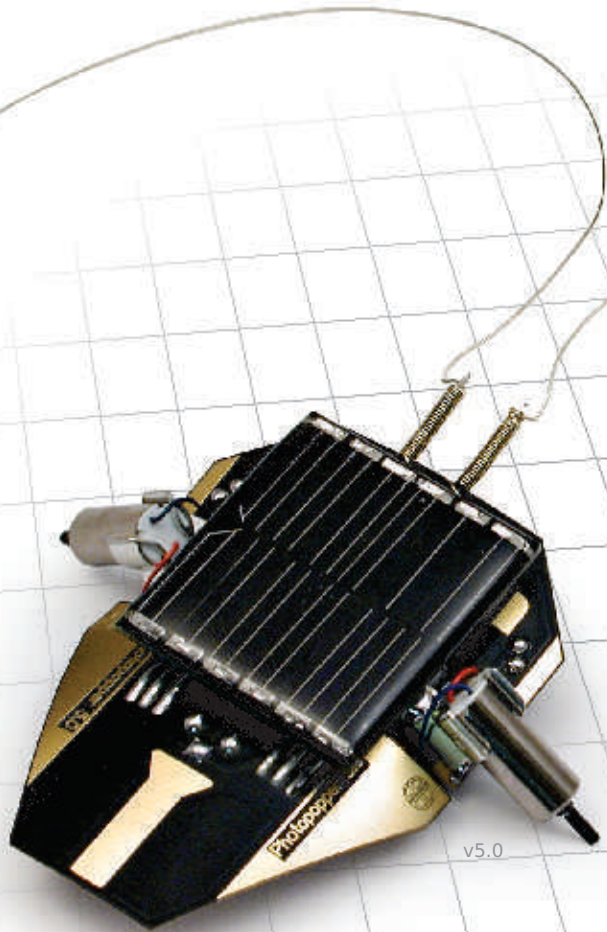

Intermediate
(Soldering
Req'd)

Build Time:

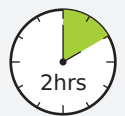

www.solarbotics.com
1-866-276-2687

We strongly suggest you inventory the parts in your kit to make sure you have all the parts listed. If anything is missing, contact Solarbotics Ltd. for replacement parts information. Okay? Good.

Disclaimer of Liability (stuff to keep the lawyer happy):

Solarbotics Ltd. Is not responsible for any special, incidental, or consequential damages resulting from any breach of warranty, or under any legal theory, including lost profits, downtime, good-will, damage to or replacement of equipment or property, and any costs or recovering of any material or goods associated with the assembly or use of this product. Solarbotics Ltd reserves the right to make substitutions and changes to this product without prior notice.

The Solarbotics Photopopper Photovore

Tools:

Basic Soldering Equipment
Eye protection (goggles)
Needle-nose pliers
Fine snips
Medium/heavy duty snips
Scissors / Knife

Heat gun, matches, or lighter (for heat-shrink tubing)
Small flat-head screwdriver
Wire cutters / strippers
Masking Tape
Flashlight or IR Remote control (for testing)
Multimeter (optional - for testing)

Parts:

- 1 - Printed Circuit Board (the PCB). This is the body and brains of your Photopopper, so DON'T LOSE IT!
- 1 - 100k trimmer potentiometer. This is usually called a "trim pot", and is used here to tune the Photopopper optics so it can accurately track light.
- 2 - 1381C Triggers (one per Millerengine). These measure the voltage from the photodiode eyes.
- 2 - 0.1 μ F (μ F - microfarad) capacitors. These set how long the motors stay on when activated.
- 2 - 2N3904 NPN Transistors (one for each Millerengine)
- 2 - 1N914 Silicon Diodes (one for each Millerengine)
- 2 - Photodiode sensor optics. These are essentially the "eyes" of the Photopopper.
- 1 - 4700 μ F 6.3 volt capacitor. This is where the power from the solar cell is stored.
- 4" - Fine twisted pair of wire to be attached to the solar cell.
- 2" - Copper wire for structural support
- 1 - Square of double-sided sticky-tape (also known as "DSST")
- 2 - Augat sockets. These look like pins with a little socket on the end. These will be turned into touch-sensors for the Photopopper.
- 2 - Sensor springs. These will be used with the Augat sockets to be the touch-sensors.
- 2"- 1/16" Heat-shrink tubing, which is used to make the touch sensors and motor wheel-sleeves
- 2 - High-efficiency low-voltage, high-speed coreless motors
- 2 - Motor mounts that look suspiciously like fuseclips
- 1 - 37x33mm Solar cell. Well, it *is* a solar-powered robot...
- 1 - Instruction guide. If you don't have this, stop right now and find it. (That's a joke...)

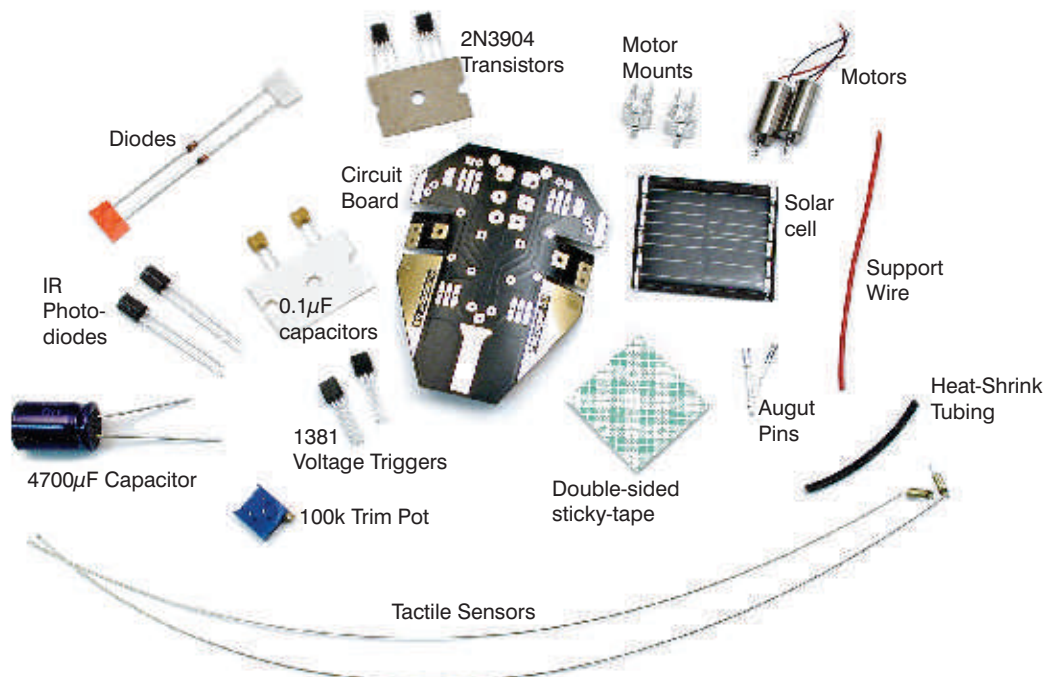

The Solarbotics Photopopper 5.0 Photovore

Introduction

BEAM Robotics is a field of robotics where the robot does not have a “traditional” brain (ie: a microprocessor), does not have a “traditional” power source (ie: a battery), and does not look anything like a “traditional” robot (ie: no blinking lights). No microprocessor means there isn't any programming to contend with, or worries about losing all your programming because the battery ran low. Being solar-powered and lacking an “off” switch means that a BEAM creature will do what it's designed to do as long as there is sufficient light, regardless if there's a person watching it or not. This means you can leave your robot alone for a while, and when you come back, it may be in a totally new and unexpected position (or for that matter, could be down-right missing)...

The Solarbotics Photopopper Photovore is a capable little self-contained robot that is powered entirely by solar energy, has light-sensing directional optics (eyes), and a pair of obstacle-avoidance sensors. The name “Photopopper” came about from the original prototype being so much faster than the others, it “popped” right past the older versions. The new version 5.0 Photopopper is even faster due to the updated “Millerengine” Solarengine that makes the robot speed over a meter (3.3 feet) a minute in sunlight!

Almost every BEAM creature makes use of a circuit called a Solarengine. This is a circuit that digests the energy from a solar cell and turns it into bursts of motion. Your Photopopper Photovore uses two Millerengine Solarengines, one for each motor. Controlling which circuit fires makes the Photovore track light.

The name *BEAM* is an acronym for **B**iology, **E**lectronics, **A**esthetics, and **M**echanics. It breaks down like this:

Biology: If you're going to create something from scratch, you model it after successful designs. We steal (um, I mean “borrow”) many good ideas from Mother Nature. We can use some really excellent materials mother nature doesn't use, like using metals, solder, wheels, and some real splendid glues. We can't include solar cells in that list because nature turns light into food all over the place. Have you seen those tree-things lately? They've got these green, flappy things that hang in the breeze and convert light into energy (truly cool). Your Photovore was originally inspired by the shape of a small Horse-shoe crab, but it seems to have turned out looking more like a robot cockroach...

Electronics: Obviously, it's a whole lot easier for us to solder a few transistors together than it is to hook up muscle tissue and nerve bundles. Silicon electronics provides us with a practical method to create our own life-like creatures, and there's none of that messy blood'n'guts stuff. Also, we keep our electronics simpler than most other robot construction methods. Simple, effective, and hard to get the software wrong (there isn't any!).

Aesthetics: This is just a fancy name for “Gee - that looks cool”. If you're going to spend the time to construct an autonomous (self-running) robot, spend a little more time to finish it properly. Hide the wires, tighten the connections, and make the solder joints clean. Besides improving it's appearance, these qualities also will make a robot sturdier and more cat-proof.

Mechanics: Solid, clever mechanics by themselves can replace a microprocessor and many lines of programming. This makes a robot more damage-resistant, and able to survive the unexpected. Often a robot is based around the computer, with wheels and motors literally strapped to a frame with a computer mounted on the top. Designing BEAM robots means the mechanical layout is just as or more important than the electronics, and usually takes longer to design than anything else.

The Solarbotics Photopopper Photovore

Critter Overview - Why it Does what it Does

As previously discussed, this BEAM robot uses only solar energy to make its way around the environment you place it in. The solar cell used in this particular application has just enough power to run one of the motors continually in direct sunlight, but what good would this do you when the sun goes behind a cloud, or you want your robot to do something else besides spin in circles? The trick is in the use of the Solarengine. It stores the power generated by the solar cell in a capacitor, which is like a mini-battery, and very efficient. When the capacitor charges up to a particular level (in this instance, between 2.9 and 3.1 volts), the Solarengine activates, and throws all the stored energy from the capacitor to the motor. This makes the motor spin good and fast, much more so than if it were connected to the solar cell by itself.

To make the Photopopper phototropic (attracted to light), the robot has to decide which direction has the most light. This Photovore design uses a pair of light-sensors arranged like a bridge to make this decision. Think of it this way: Imagine a level see-saw with a water bucket at each end. When a rain cloud comes near, it starts filling the buckets with water, but the one nearest the cloud fills up faster. As soon as the one bucket fills, it makes it's end touch down and spill out. Using this analogy, the buckets are the light-sensors, the rain cloud is the source of light, and the spilling out is the signal for the proper Solarengine to trigger. You will be able to set the "see-saw point" using the trimmer potentiometer so your Photopopper will go straight towards light sources. Or if you want, you can tweak it so that it will "prefer" to turn one way versus the other simply by changing the way the two light-sensors "balance" each other on their electronic see-saw.

The light-sensors are very good at what they do. They're designed to view a 100 degree angle, and will not let the Photopopper get itself caught in a shadow while there are better sources of light nearby. One of my favourite past-times when I torment (um, I mean observe) my Photopoppers is to herd them around their cage using a shadow cast by my hand, or a book. Sometimes they aren't tricked, and will try to jump through the shadow to where the light looks better!

The touch-sensors you will be building will give the Photopopper the ability to avoid obstacles in its way that it didn't "see" with the optics. These sensors work in a simple manner - they shut off the Solarengine controlling the motor on the opposite side. When the Photopopper bumps into something against it's left sensor, it makes sure the left motor activates first. This makes the Photopopper pivot around the right motor until the sensor comes free, and then the robot continues on it's merry way.

There is an exception to this rule, and that is when both sensors have been activated. Unfortunately, the Photopopper isn't smart enough to know how to back out of a trouble spot, so in this case it will ignore the touch-sensors and try to bully it's way through the obstacle with brute force. It may not seem like it would have a chance against another BEAMbot or obstacle in a display area, but it will probably surprise you. Slow, but steady, consistent attempts can prove to work quite well. Just don't blame it for knocking your flower vase off the shelf (it was the cat's fault - honest!).

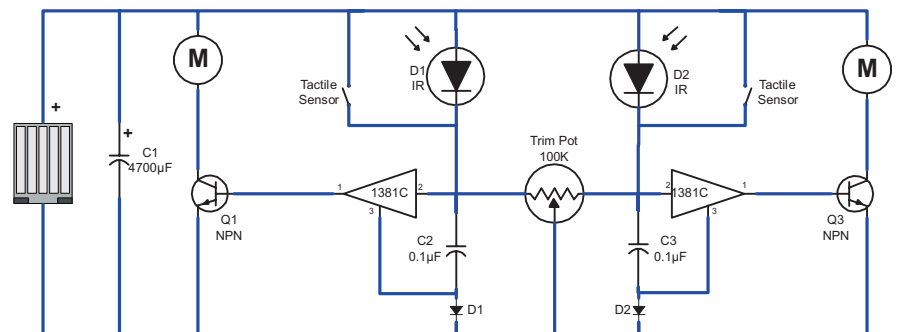
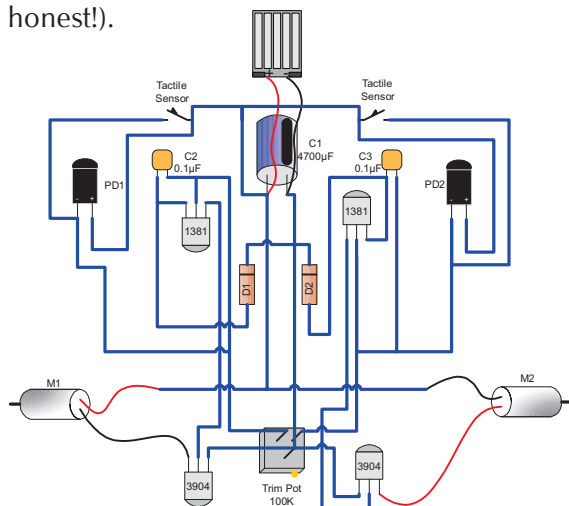

The Solarbotics Photopopper Photovore

Photovore Behaviours

Your Photopopper is designed to exhibit two main behaviours: Light-seeking and Obstacle avoidance. The primary goal of any Phototropic (light-seeking) robot is to find and maintain access to a source of light (it's primary source of energy). The secondary goal is to keep from getting stuck. Your Photopopper is equipped with optical sensors to find the light, and touch sensors to avoid any immediate obstacles. Interestingly enough, the optical sensors can sense obstacles by the shadow they cast, so your Photopopper may occasionally surprise you with their adeptness.

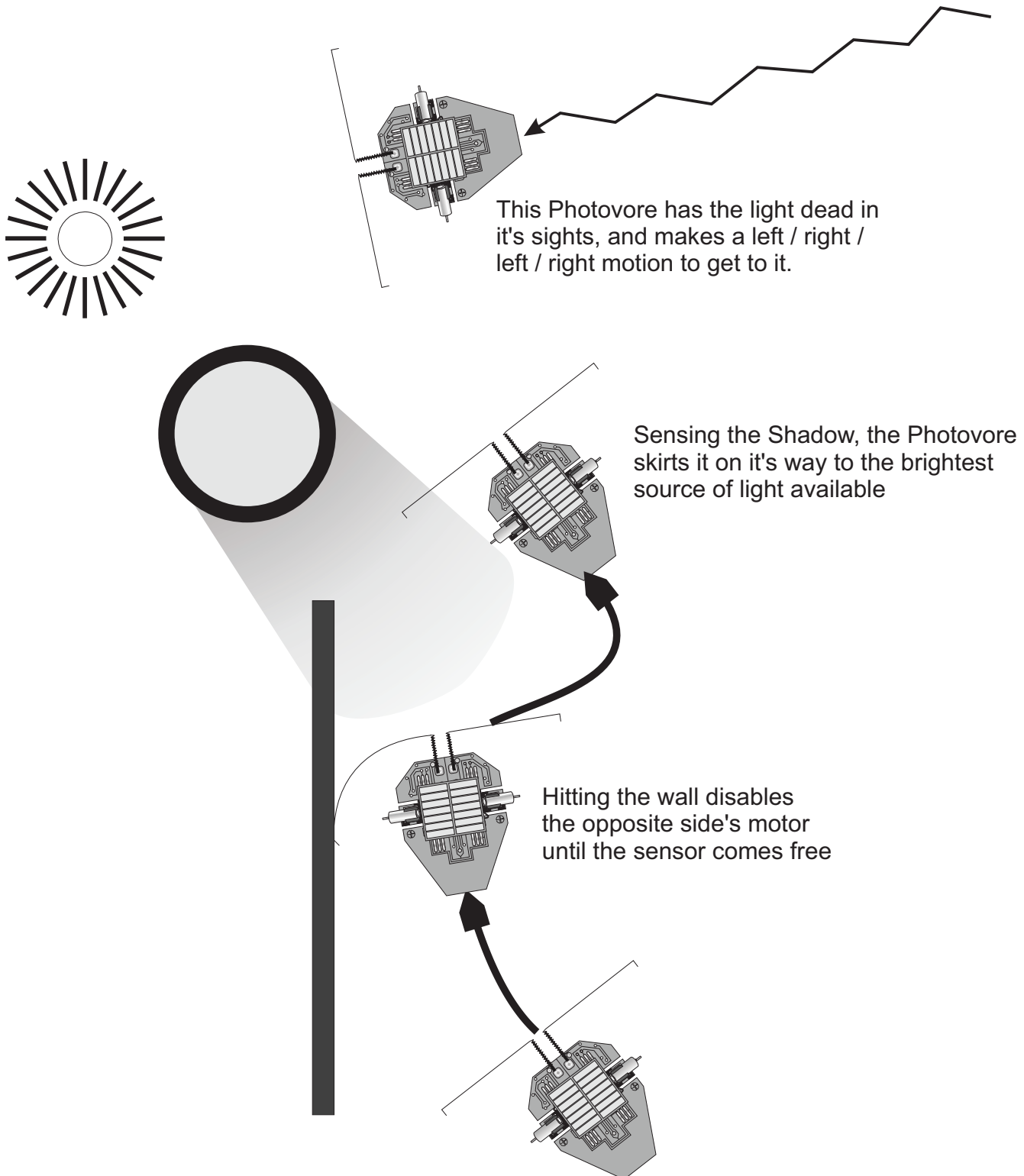

Assembly - Bringing your Photopopper to LIFE!

(insert "maniacal laughter" here)

Step 1: The 2N3904 Transistors

Start with the **2N3904** transistors. Now, don't just plug them in and start soldering - you have to get them in **correctly**.

Transistors have a flat side and a curved side. Put them in so they match the outline at the spots labeled '**3904**', and push it in about as far as it will go. Then bend the legs over so they stay in position, then solder them down. Remember your soldering lesson! Use the soldering iron to heat the parts, so the solder melts to the parts and not the iron!

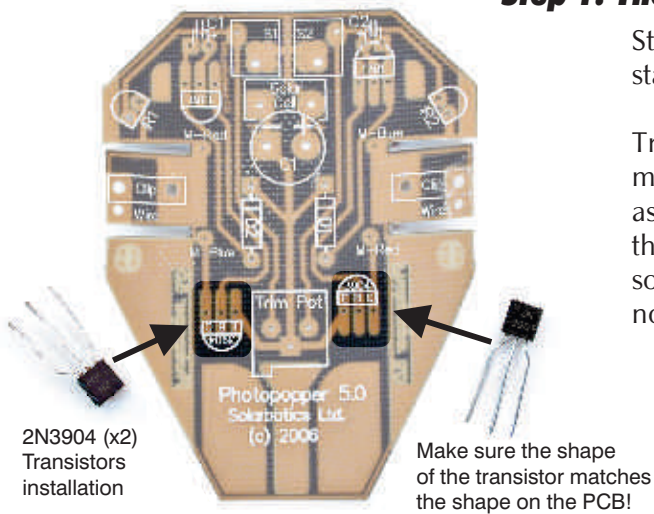

Fold the leads over on the topside...



...solder it down, and snip the leads

Step 2: The 100k Trimpot

The **100k Trimpot** fits into the location '**Trim Pot**' only one way, so there's little chance of getting it wrong.

Like the transistors, put it in all the way, bend the leads over, solder, then snip!

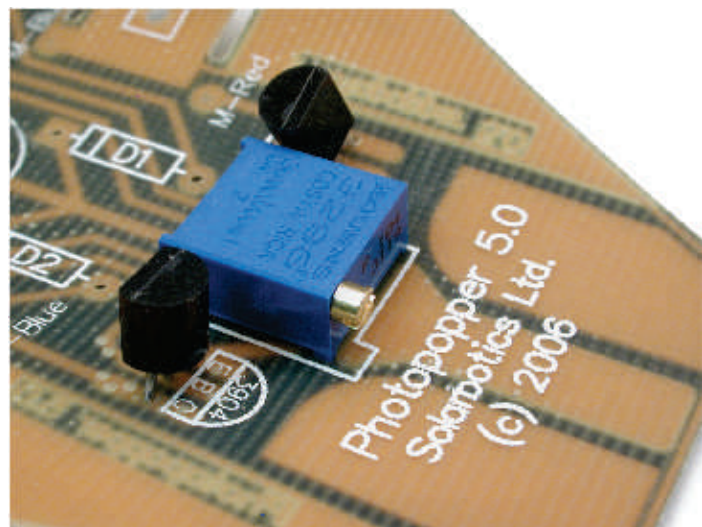
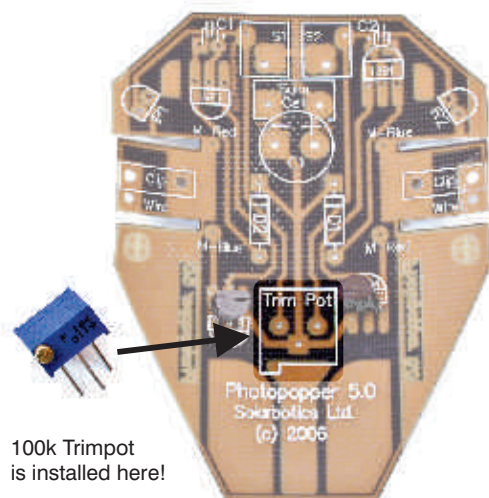

This is what the transistors & trimpot installation looks like when finished. Note the way the transistors are pointing - curved side to curve symbol!

The Solarbotics Photopopper Photovore

Step 3: The Diodes

The next victim on our soldering list are the **diodes**. Like the transistors, they have to be installed the right-way around in positions 'D1' and 'D2'.

Start by bending the leads over, but not right next to the diode body. Bend the leads so they're spaced about the same as the holes at positions 'D1' and 'D2'. This will let you install the diodes nice and flat against the PCB.

There's a black band on one side that has to match the band on the circuit board. Install it like it's shown in the image, and you'll be fine.

Bend the diode so it matches the shape of the pad. See that the band on the diode matches the band on the PCB?

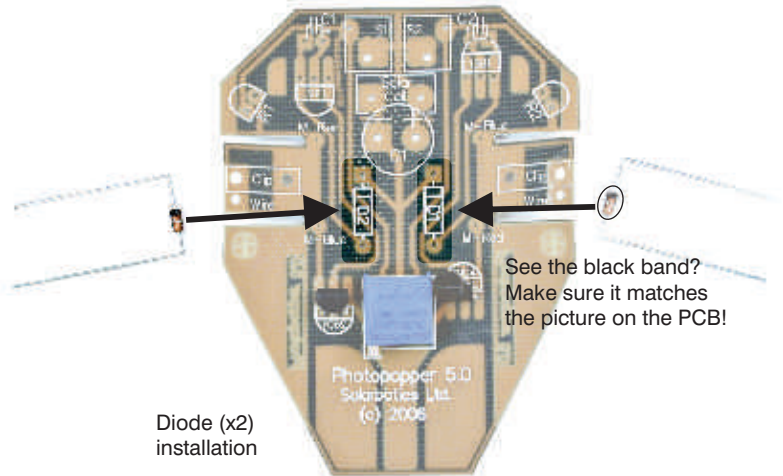
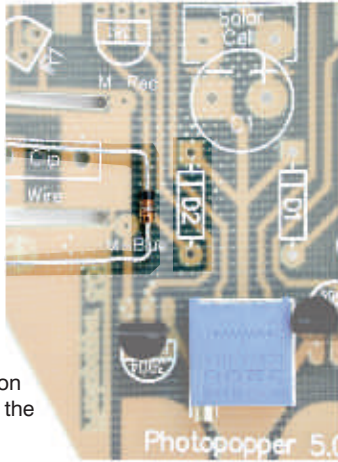

Step 4: The 1381 Voltage Triggers

The two 1381 voltage triggers are much like the transistors - they have to be installed the right way around, or they won't work!

Match the curve of the 1381 with the curve printed on the circuit board in the positions '1381'.

Install the 1381 just like you did the transistors. Match the curve with the curve on the PCB.

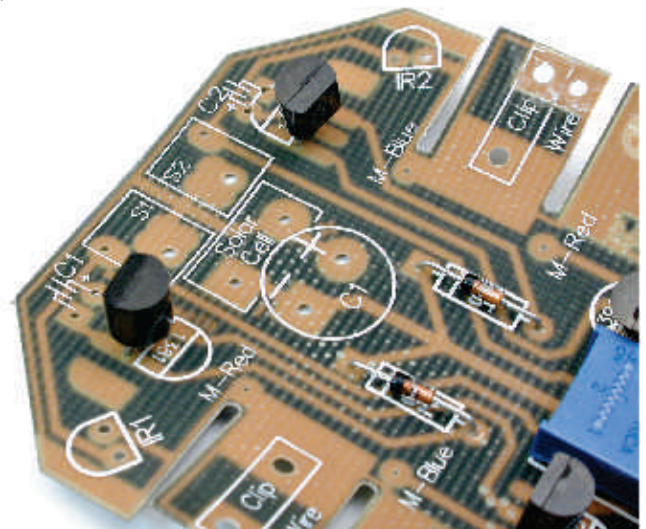
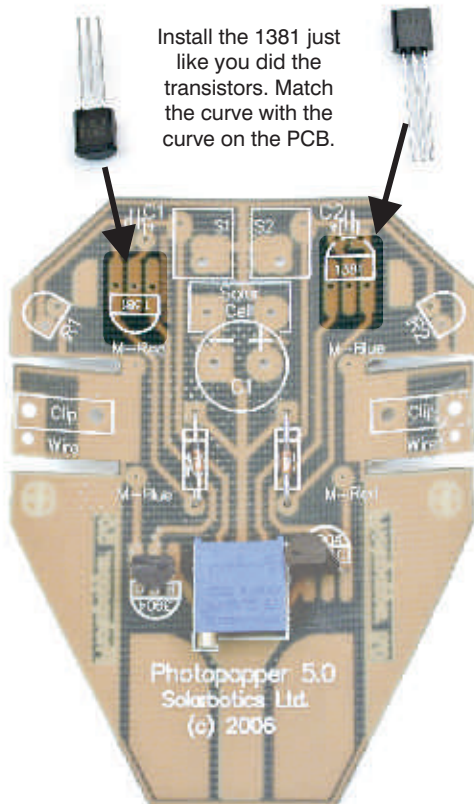

Close-up of the 1381 and diodes installed on the PCB. Note the directions that these parts are facing - they don't work when installed backwards!

The Solarbotics Photopopper Photovore

Step 5: The Small 0.1 μ F Capacitors

The two 0.1 μ F capacitors are soldered into locations 'C1' and 'C2'. They don't have a polarity, so you can stick them in either way. Just remember to pull them down close to the board before bending their leads over and soldering them in and snipping the leads.

The capacitors set how much of a pulse the motors get when the Millerengine fires. These are sized so pretty much most of the power gets dumped, but if you wish to experiment, try replacing them with a larger or smaller values. Or go really funky and change only one. You'll have an "Igor" style Photovore that takes one large step, followed by several small steps!

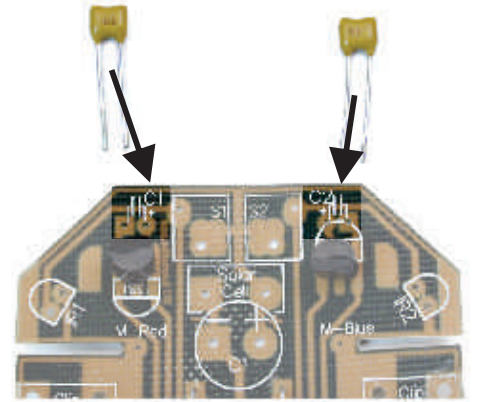

Installing the 0.1 μ F C1 & C2 Capacitors

Step 6: The IR Light Sensor Photodiodes

The Infrared sensitive Photodiodes are tuned to look for IR light, which is pretty common, especially in sunlight and most lightbulbs. The more light that they see, the more power they pass to the 0.47 μ F capacitors you installed in step 5.

Unlike the capacitors, *these parts are polarity sensitive* - you have to get them in the right way before they will work. Just make sure the curved face on the IR sensor matches the curve on locations 'IR1' and 'IR2', and you won't go wrong. Double check against the pictures below to be sure, ok?

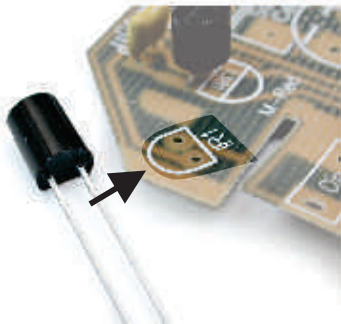

See the curve? Match it with the curve on the circuit board

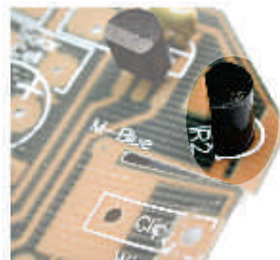
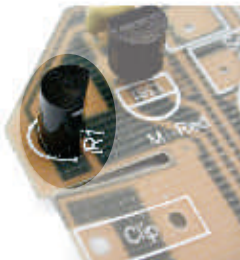
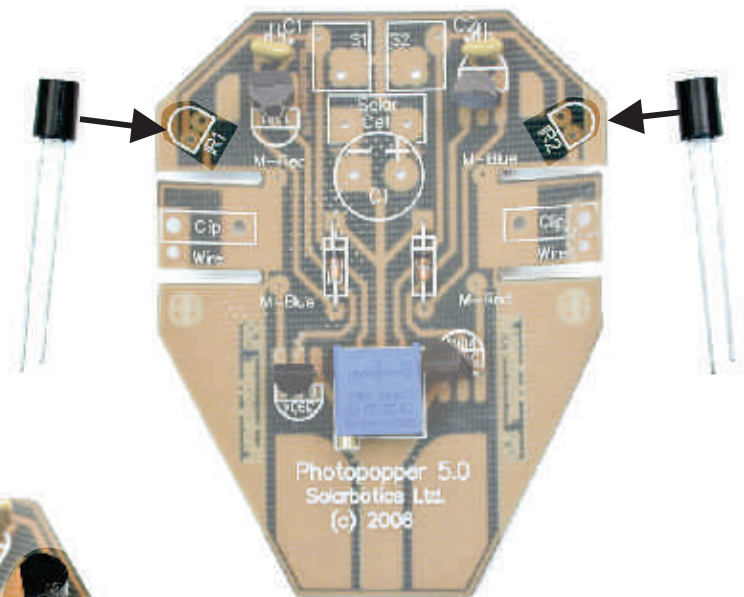

Note how the curve of the IR sensor matches the curve on the circuit board. With this many pictures, you should have nooo problem!

The Solarbotics Photopopper Photovore

Step 7: The 4700 μ F Power Storage Capacitor

The 4700 μ F capacitor is the storage cell that holds the power the solar cell generates until the two Millerengines figure out who gets to eat it all. This is another “polarity-sensitive” device, which means that it won’t work if it’s installed backwards.

Note the side that has the stripe - this is the side that is negative (-), and gets soldered into the square pad marked with the ‘-’ (bet you saw that coming, right?).

Start by bending the capacitor leads down 90° *just like it’s shown below*. If you bend it the other way, the only way it will fit in is backwards (bad!), so do it as shown below. Make it lay flat to the circuit board, and solder it in!

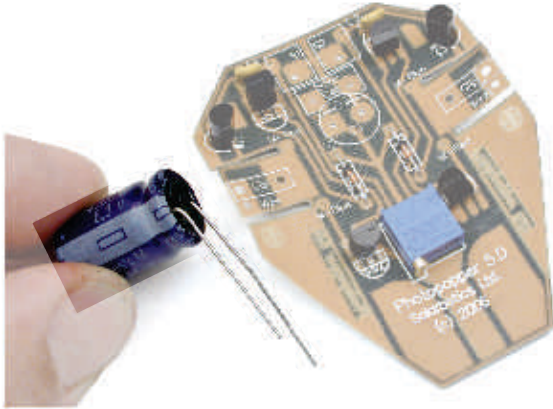

Bend capacitor leads down, while holding it with strip on this side

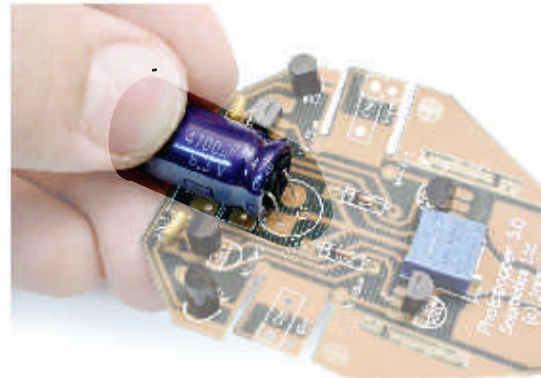

Install the 4700 μ F capacitor flat against the circuit board

Step 8: The Motor Mounts

The motor mounts *may* look suspiciously like fuseclips, but they aren’t. Honest. Really. No matter, let’s install these on the circuit board. We’re installing these **on the topside of the circuit board**. This is the on the side opposite to where everything you’ve been installing. After inserting them, bend the leads over underneath, or solder the mount to the gold pad on the top of the circuit board.

The mounts have little alignment tabs that butt up against the ends of the motors we’ll install later. **Make sure** you put the mounts in so these **tabs are on the inside**. If you don’t, you’ll have to flatten them out to make the motor fit.

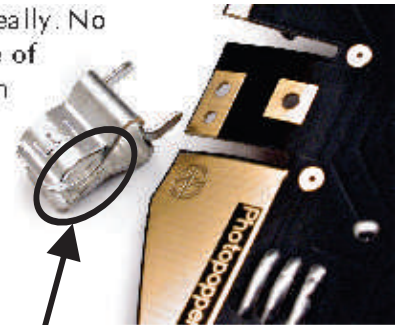

This is the motor tab.
Learn this, young apprentice!

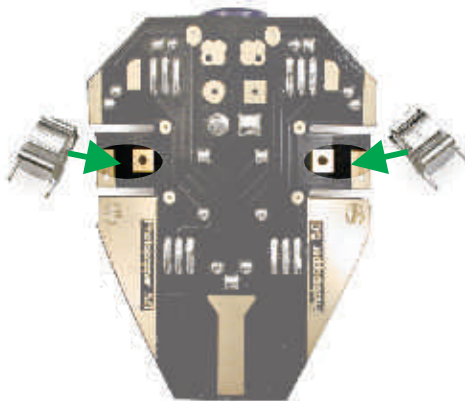

Install the motor mounts **on top** of the circuit board at these locations. Make sure the tabs are towards the inside before soldering or bending over the motor mount leads!

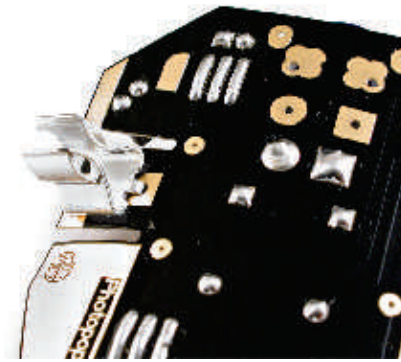

Left motor mount installed. Note tab position!

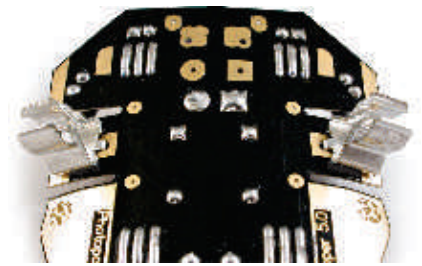

Both motor mounts ready

Bend the mount leads over with pliers, or solder it to the solder pads



The Solarbotics Photopopper Photovore

Step 9: The Support Wire

We make the circuit boards so they have a gentle bend, but we add extra support by soldering in a wire across the motor mounts.

Start by stripping 8mm (3/8") of wire insulation off one end, and bend it over.

Bend the wire so it lays across your Photopopper to the other motor mount. Trim the wire and strip off a similar amount so you can make the same sort of connection on this side.

It's best if you can get a helper to bend the board a bit while you make this second connection, so it pulls the two sides together a bit. If not, don't worry - we have a trick to tighten up the wire. Get it as snug as you can, and we'll tweak it up later during final assembly.

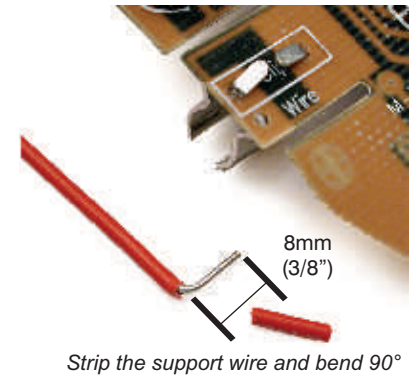

Strip the support wire and bend 90°



Insert the wire from underneath and lay it next to the motor clip

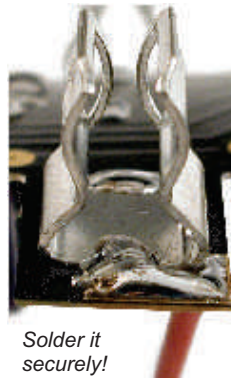

Solder it securely!

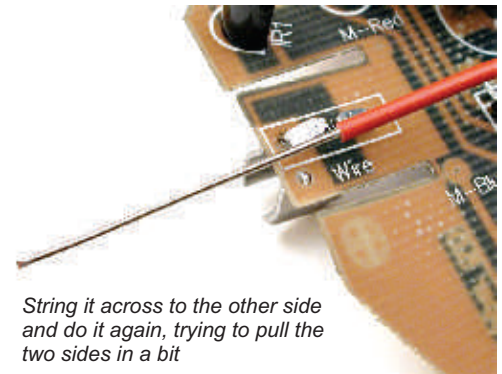

String it across to the other side and do it again, trying to pull the two sides in a bit

Step 10: Motor Installation

Doing the motor connections are pretty easy. Snap the motor in, and run the wire to the underside where you connect the **red** wire to 'M-Red' pad and the **blue** wire to "M-Blue" pad. Do that for each motor, and you're set!

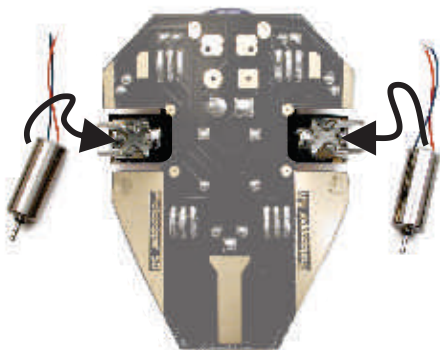

Snap the rear of the motor into the motor clip and snug it up to the tab

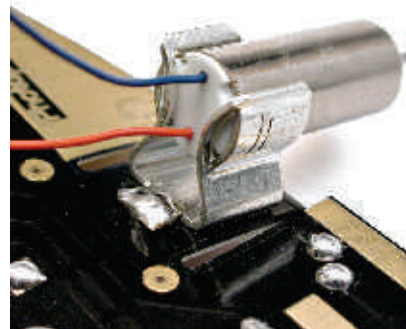

The motor is tucked right up to the clip, but keep the motor wires out of the way

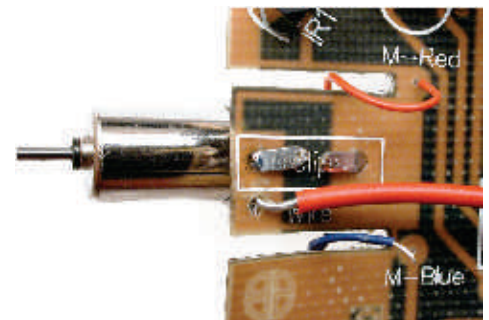

Run the red with under to the 'M-Red' pad, and the blue wire under to the 'M-Blue' pad



Bend the wires over when they poke through the pad hole. This will keep them from falling back out when you solder them.

The Solarbotics Photopopper Photovore

Step 11: The Solar Cell

The solar cell we're using is very good in sunlight, and still pretty good under indoor lighting, *except* for fluorescent lights. Although power efficient, fluorescent bulbs just don't have the right color of light to properly feed solar cells.

Start by unwinding the twisted black & red wire 2.5cm (1") on each end. Strip off the insulation so you have at least 3mm (1/8") of wire poking out. We'll solder the **red** wire to the solar cell '+' pad and the **black** wire to the solar cell '-' pad.

Solder the other end of the wire to the top of your Photopopper on the large round and square pads. The black '-' wire goes to the **square** pad, and the red '+' goes to the **round** pad. Don't push the wire too far into the hole before soldering - you have to make sure the solder connects to the metal core of the wire!

Take your piece of double-sided sticky-tape ("DSST") and peel off one of the backings. Fold it in half, peel the other side, and stick it to the middle of the of your solar cell. Tuck the extra wire around underneath, and glom the solar cell on top of your Photopopper! Technically, your robot is now *alive*!

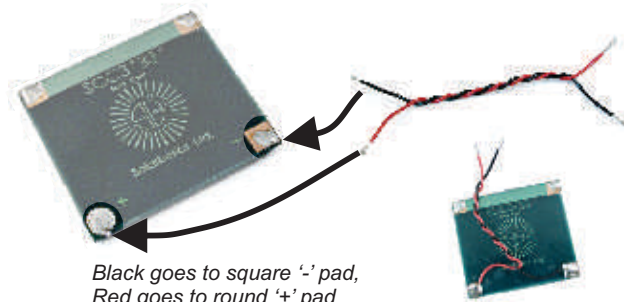

Black goes to square '-' pad,
Red goes to round '+' pad

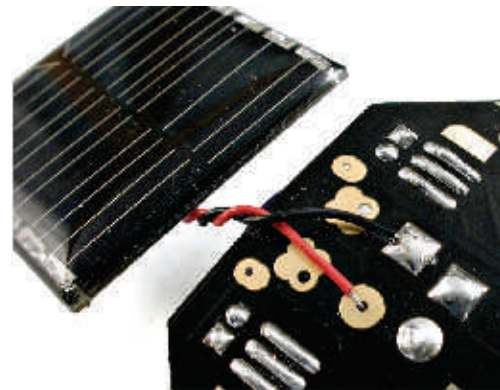

Solder the black wire to the Photopopper square pad,
and the red wire to the Photopopper round pad

Peel off one backing, and
fold the DSST in half

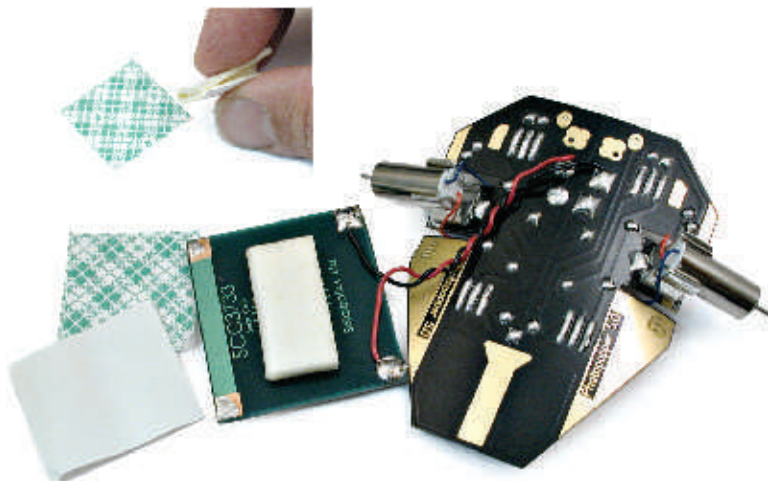

Peel off the other half, then squish it
hard onto the back of the solar cell!

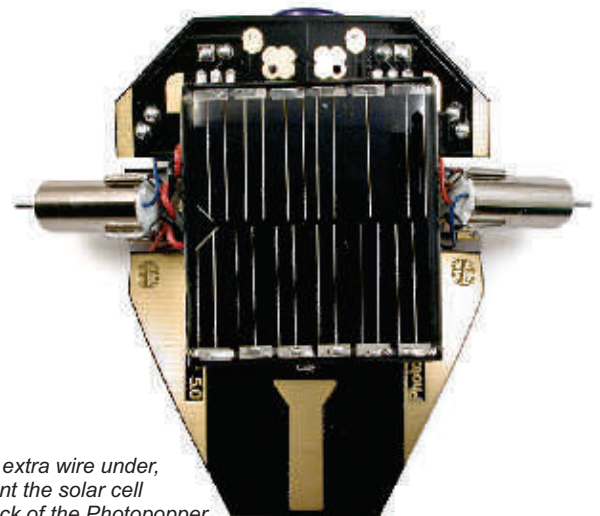

Tuck the extra wire under,
and mount the solar cell
to the back of the Photopopper.
Try not to cover the solder pads
on the front middle!

The Solarbotics Photopopper Photovore

Step 12: "It...LIVES!!!" (or, "Testing and Tuning")

Find yourself a good source of light (remembering that fluorescent *isn't!*), and hold your Solarbotics Photopopper under it. You should hear a frequent "BZzzz..BZzzz..BZzzz". Put your fingers on each motor shaft and move the robot so one side gets more light, then shift over to the other side. You should feel the robot trying to push itself towards the light! Excellent - now you know your Photopopper is alive, but let's try tuning it a bit.

Let's make sure both Millerengines are functional. We use the trimpot to tune out any minor differences between the Millerengine circuits, so we'll use the trimpot to test each side of the robot.

Put your Photopopper down on a table in front of a light source. If it meanders off to one side, that means the differences in the two Millerengine circuits need balancing (which is most likely to happen). Turn the trimpot screw in the direction that needs to be more active. For example, if your Photopopper is moving to the right of the light source, you need to make the *right* motor more active to put it back on course, so turn the trimpot screw clockwise (to the right).

If your Photopopper does little circles on the table, that means one circuit or motor isn't working, and you need to double check your solder connections and components. Compare everything to the photos - everything you installed should look just like the pictures.

Step 13: Trouble Shooting

Hopefully you won't need this section, but if you do, here a few checks and tests to perform if your Photopopper is acting up. Above all else, make sure that there are no solder-bridges. This is when solder crosses from one pad to the next - a condition that should *never* be allowed to happen. It can also happen if you *don't* clip the extra leads or wires from underneath the component you soldered it. The extra lead can touch and short out against other parts. Frayed wires can also be at fault if a strand or two didn't get soldered into the hole.

No movement / action: This can be attributed to many factors. If you have a multimeter, try the tests in the brackets ().

- Solarcell hooked up backwards? (voltage positive on pad marked "+")
- Power capacitor hooked up backwards? (voltage climbs only to 1.5-2 volts)
- Motors hooked up to pads "M-Blue" & "M-Red"?
- Trimpot installed?
- Transistors in correct place and orientation?

Only one side works: When only one side works, you can compare it against the side that is working. Check and compare these conditions:

- Motor hooked up to pads "M-Blue" & "M-Red"?
- Trim pot adjustment turned all the way over to one side?
- There's a bridge across the sensor pin pad to the spring pad
- The connection pads on the solar cell may be touching a part of the circuit board below it

The Solarbotics Photopopper Photovore

Step 14: Adding Motor Wheel Sleeves

The motors we use for the Solarbotics Photopopper are actually quite good quality *coreless* DC motors. This means they spin *quick*. To make best use of this power, we'll put some heat shrink tubing on each motor output shaft to act as "motor wheel sleeves". They're not quite tires, but they sure make it move quicker!

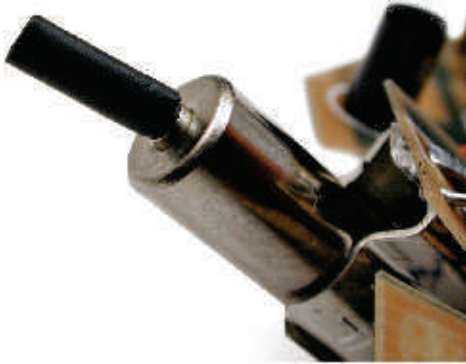

Cut a 6mm (1/4") length of heat-shrink tubing and stick it on the end of the motor shaft

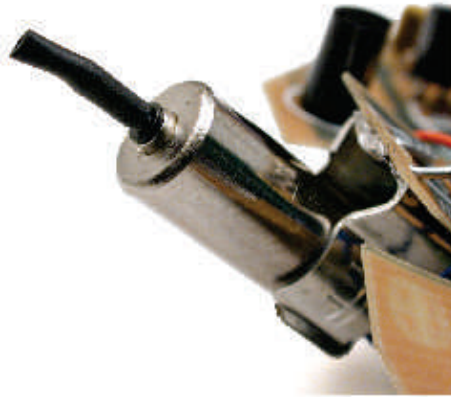

Use your heat-gun, match, or lighter to gently heat it until it shrinks down tight to the shaft

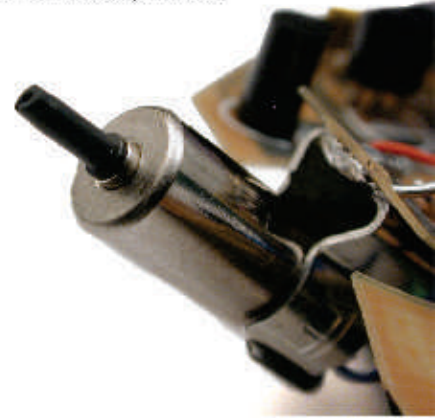

Trim it so there is about 1.5mm (1/16") left on the end. Now do it for the other motor!

Step 15: Sit, Photopopper, Sit!

Now that we have the wheel sleeves installed, let's adjust how high the your Solarbotics Photovore sits.

If your Photopopper can't quite get it's wheels to touch the ground, it is not curved enough. This is why we installed that support wire in step 9. We'll simply grab the middle of the wire with our needle-nose pliers and give it a nice, small half-twist (or more, if you need to). This will shrink the length of the support wire, pulling the motors in. Now your Photovore should be touching the table with only two wheel sleeves and the 4700 μ F capacitor!

Don't pull the motors too much in - just enough to make enough space. Too much, and you risk breaking something!



Too flat! Photopopper is doing belly-scrapes!

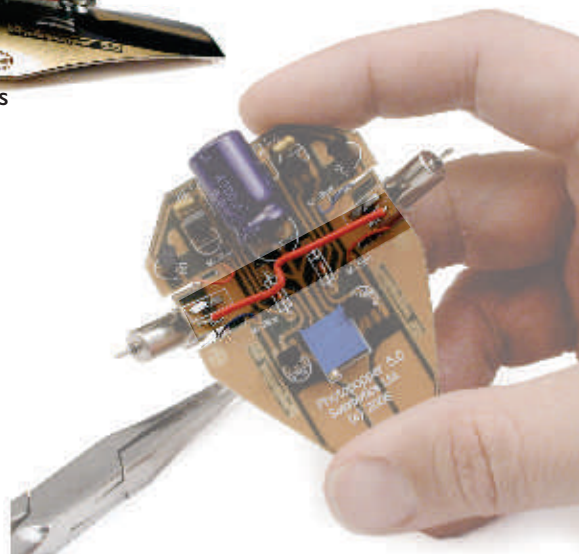

Give the support wire a half or full twist to pull the motors closer (may take a few tries to get it just right).



Much better. Sitting on just 2 motors and the main storage capacitor!

The Solarbotics Photopopper Photovore

Step 16: Touch Sensor Construction

We've been using these "Omni-Directional Tactile Switches" for over a decade, and they work great. Take your time while building these, and they'll let give your Solarbotics Photopopper great obstacle-detecting ability.

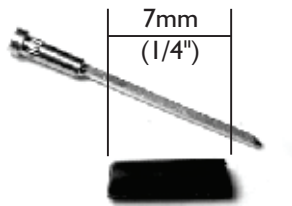

1. Find an Augat Pin and your heat-shrink tubing. Cut a 6mm (1/4") piece off of it.



2. Use pliers to hold the back of the pin while you get ready to heat the tubing.



3. Heat the tubing until it snugs down to the pin. Don't burn or scorch it!



4. Gently cut the tubing below the neck so there is a 2mm (3/32) adjustment sleeve



5. Slip the spring onto the pin, short spring stub towards the sleeve. Start by pushing it on, then twisting it onto the heat shrink sleeve.

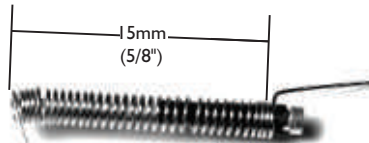

6. Stretch the spring out so it just reaches the tip of the pin. Don't pull too hard - use several short pulls!



7. Use the knife to slide the adjustment sleeve 3/4 the way down the pin

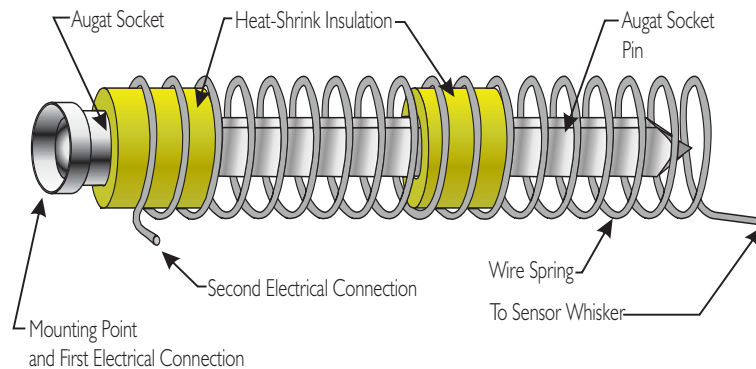

Now build the second one and we'll get to installing them on your Solarbotics Photopopper!

Step 17: Touch Sensors Installation

Each touch sensor is installed to a pair of pads on the front nose of the Solarbotics Photovore. First pre-tin the **large** solder pad by melting some solder to it. Slide the short sensor spring stub into the hole of the **small pad** next to it, and solder the end of the pin to the **large pad**. If the stub doesn't quite fit, feel free to bend the stub back and around the other way to make it reach.

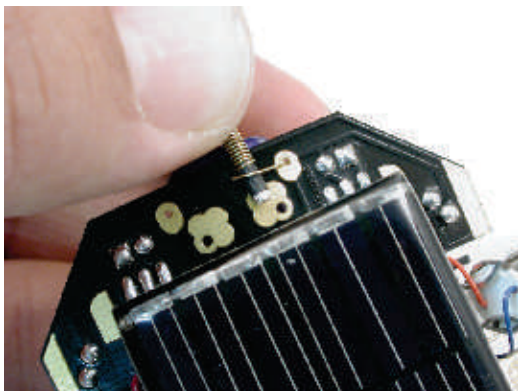

Arrange Sensor so the pin head is on the big pad, and the sensor spring stub goes to the small stub.

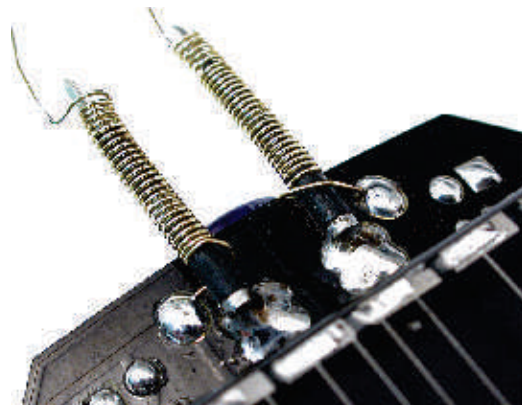

Finished sensor spring installation

Continued next page...

The Solarbotics Photopopper Photovore

Step 17b: Touch Sensor Forming

Now that you've built your sensor, installed them, you'll probably want them to look better than a "bad whisker day". To get them to curve out and around is a bit of an art. You want your sensors to reach out as far forward and to the side as possible for the best obstacle-detection, but this has to be balanced against how hard it will be to manage such a long whisker. Ideally, one sensor should reach out a bit further than the other in case it heads directly into a wall. With one longer whisker, it will have a built-in preference for which way to turn.

The wire used for the whiskers is tough and durable, and can be convinced to curl in by pinching the wire gently between your thumbnail and index finger. Not too hard now! The harder you pinch, the tighter the curve becomes. Do it hard enough, and it will turn into a piggy-tail!

There will be times where "thumbnail" curving won't be enough. Use fingers or pliers to put harder bends into the whisker to bring them into alignment. Whisker forming can take some time to get right, so don't hesitate to try one shape for a while, then adjust it more.



Form a curve by pinching the wire between your thumbnail and index finger, and pulling it through

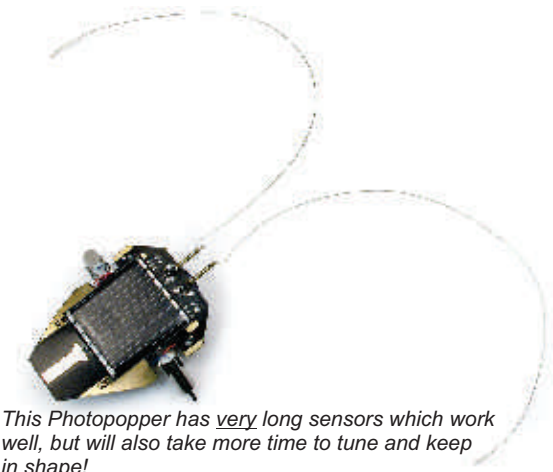

This Photopopper has very long sensors which work well, but will also take more time to tune and keep in shape!

Step 17c: Touch Sensor Adjusting

You now have your touch sensors installed and formed, so the last step is to make sure they are adjusted and working. The touch sensors are simple switches. When the spring around the pin bends, it touches the pin on the inside, activating the touch-detection circuit.

You have to make sure that the pin in the middle of the spring is right in the middle. The best way to do this to bend the spring at the base of the pin and try to force the whole works up/down/left/right until it's right in the middle. Or can use the "adjustment sleeve" you made in step 16.7 by sliding it towards the tip of the pin until it centers the spring off the pin. Lastly, you can bend the pin itself, but not too much, as it will snap.

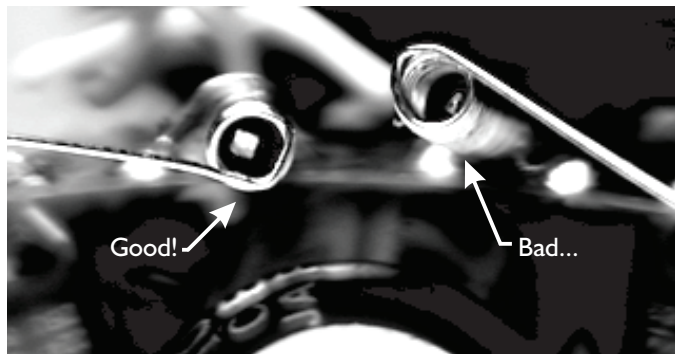

See how the touch-sensors should look from straight head-on. Fix it so the pin sits dead in the center, not touching the spring at all. When your Photopopper bumps into something, the spring will bend and contact the pin, closing the circuit that will make your robot turn away from the obstacle.



The Solarbotics Photopopper Photovore

Although interesting to watch by itself, you may eventually want to try placing it in an environment with other BEAM creatures and robots. When there are more than just one or two robots interacting, patterns and behaviors may emerge where there were none before. Not that this is a way for us to promote the purchasing of 2, 3 or even two dozen more photovores (well, that would be nice...), but it is true that behaviors are easier to recognize when you have several creatures to observe.

In the future, we're hoping that many more photovores of different sizes and shapes are constructed by BEAM enthusiasts. As the photos on the back page show, they come in all shapes and sizes. The Solarbotics Photopopper is just one of many successful design layout ideas that have "come across the desk". If you have your own idea of how a solar powered photovore should look and behave, pursue it.

We hope that you've had fun working on your Photopopper, and now that it is finished, you should expect to enjoy it for another 10 or 20 years. Mind you, that only is true if it manages to escape the occasional cat or baby that may take interest in its wanderings.

If you find you're having more problems with your Photopopper than what you can handle, contact us before sending it back so we can give you appropriate shipping instructions. Robots returned without proper shipping documentation will not be received and serviced!

Solarbotics Ltd.

101 3740D 11A St NE

Calgary, Alberta, Canada T2E 6M6

Ph: (403) 232-6268

Toll Free: 1-866-276-2687 (1-866-B-ROBOTS)

Fax: (403) 226-3741

Website: <http://www.solarbotics.com>

Email: info@solarbotics.com

© Copyright Solarbotics Ltd., 2006

Liked the Photopopper? Want more?

There are several more kits Solarbotics offers for any skill level!

Based on our HexPummer, this kit charges all day from the SCC3733 solar cell. In the dark it "pumms" the two ultra-mega-super-bright LEDs and casts artistic silhouettes against the walls of the lantern.

K HP-L HexPummer Lantern \$33.50USD/CAD



The SolarSpeeder 2 Kit is a very quick Solaroller that can cover 3 meters (10 feet) in under 40 seconds in direct sunlight. Simple to construct and a blast to watch, this is a great kit for all beginners!

K SS Solarspeeder \$27.50USD/CAD

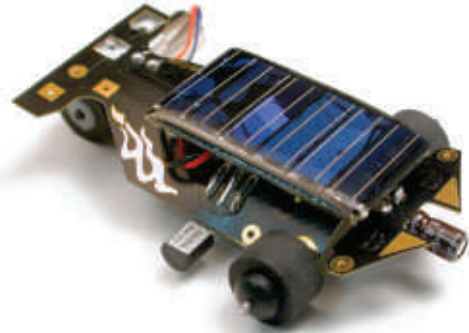

Herbie the Mousebot is a 9-volt battery-powered robot that loves to chase flash light beams. If there are several Herbies in the same area, they can be configured to chase each other! These little robots are so quick, you have to run to keep up to them!

K HM Herbie the Mousebot \$39.95USD/CAD

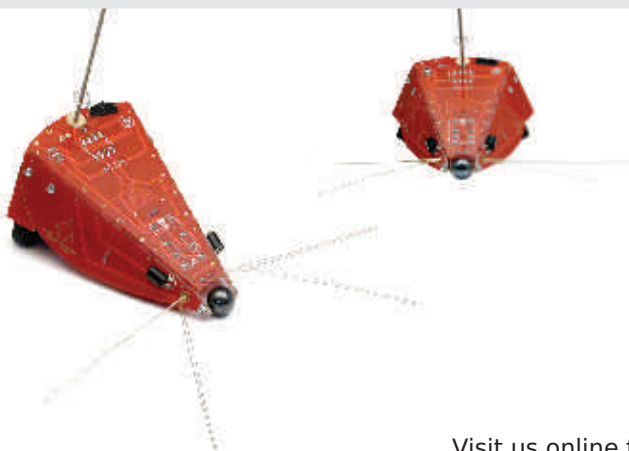

Wishing you had a bit more of a vicious light-seeker? Well, try our Turbot! Dubbed the Velociraptor of the Robot Jurassic Park, the K TB Turbot moves by flipping end over end on it's long legs. It's capable, but smart enough to let go when it's taking on too big of a challenge!

K TB Turbot. \$59.95USD/CAD

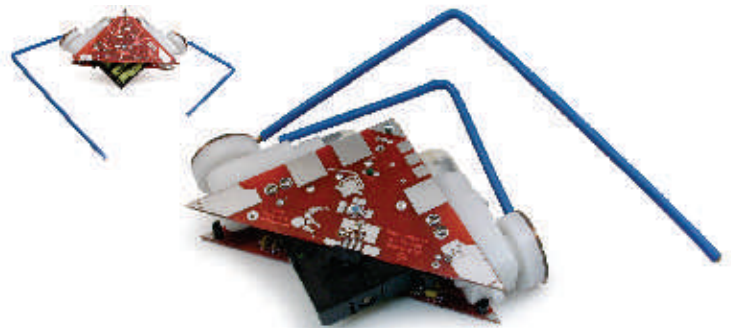

Visit us online for more info and cool stuff:

www.solarbotics.com

Solarbotics Ltd.
3740D - 11A Street NE, Suite 101
Calgary, Alberta T2E 6M6
Canada

Toll Free: 1-866-276-2687
International: +1 (403) 232-6268

Fax: +1 (403) 226-3741

 Made in Canada