

Solar Marble Machine Kit

*The fun of a Marble Machine,
miniaturized for your desk
and Solarengine™ powered!*

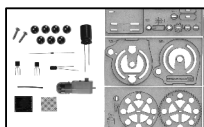

Compact solar cell and circuit board.



All electronic and structure parts included.



Precision laser-cut wood construction.

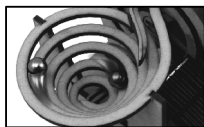

Marbles run to the top of a wooden spiral and roll back down.

 Ages 12+

 Solar powered
(no batteries required)

 Soldering & basic tools required

 1.5 hours build time



SOLARBOTICS[®]
Ltd

www.solarbotics.com
1-866-276-2687

 **WARNING: Swallowing hazard!** Product contains small parts. Finished kit is not for young children under five.

Solar Marble Machine Kit

PARTS LIST

a) Set of wooden parts

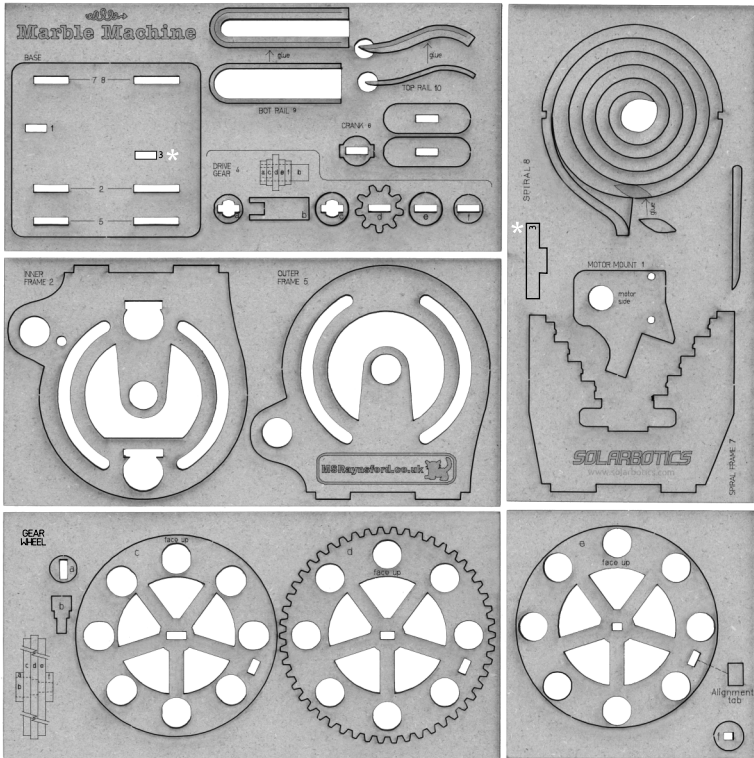

b) GM9 Motor

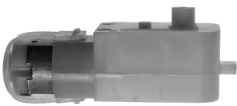

c) 2 x #4x1/2" Screws



d) 7 x 3/8" marbles

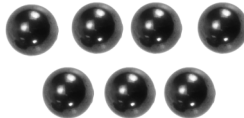

e) 4700µF Capacitor



f) SCC3733 solar cell



g) PN222A transistor



h) MCP112 trigger



i) Double-sided sticky tape



j) 0.47µF capacitor



k) 2 x 2-conductor wire



l) Diode



m) Solar Engine circuit board



* not used in this assembly

Solar Marble Machine Kit

TOOLS

Assembly is very straightforward, but you'll still need:

- Soldering equipment (soldering iron, solder)
- Wire cutters
- Wire strippers (22 gauge)
- Philips #1 screwdriver
- Wood or white glue
- Tweezers (optional)

ASSEMBLY STEPS

The Solar Engine circuit board is the soul of your machine, and allows it to run even when not in direct sunlight. We will complete and test it before the starting the wood frame.

 The introduction to soldering video: slrbtcs.co/solderVid2

1. Solar Engine Circuitry

1.1

Find the transistor (g), MCP112 Trigger (h), small 0.47 μ F capacitor (j) and diode (l) and trim all the paper off the end of the leads.

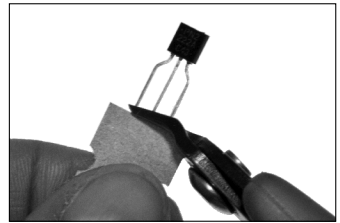

1.2

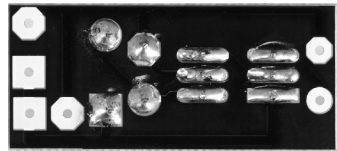
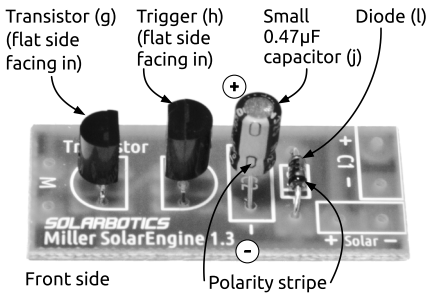

Back side

Solder these parts to the Solar Engine circuit board (m) as shown in the picture. You will need to gently squeeze the trigger's and transistor's leads to make them slide into the holes. This is done to keep them in place while soldering. No need to hold them and burn your fingers!

Make sure to match the orientation - these components do not work backwards.

1.3

Prepare the large 4700 μ F capacitor (e) by gripping it with the stripe facing you. Bend the leads 90° over to the left.

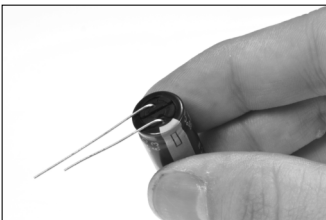

Then solder it to the Solar Engine like shown. When finished, clip any leads sticking through the bottom of the circuit board.

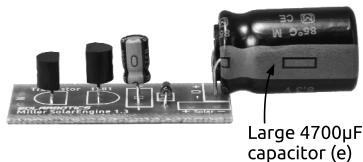

Solar Marble Machine Kit

1.4

Separate the ends of the wire (k) by about 15mm and strip them by 5mm. Solder one end of the wire to the motor (b), and the other end to the Solar Engine (marked with an "M"). Polarity is not important so do not worry which connection is positive or negative.



1.5

Strip the second conductor wire (k) on both ends by 5mm (3/16"). Solder one end of the wire to the solar panel's positive and negative leads, and the other end to the Solar Engine. Make sure that **positive** is soldered to **positive** and **negative** to **negative**. Polarity is very important in this step!

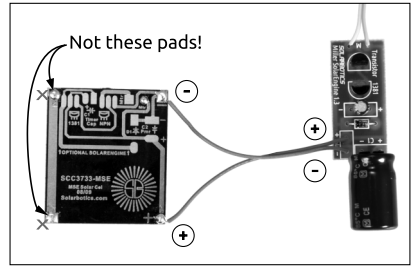

1.6

Test the Solar Engine before further assembly. Expose the solar cell to sunlight for 10 seconds while checking for pulses of motor movement. No? Check your soldering!

2. Motor & Solar Mounting

2.1

Use the #4 screws to attach the motor to the wooden holder.

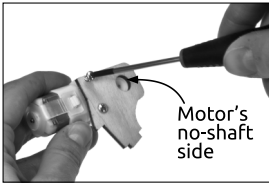

Cut the double-sided sticky tape in half. Peel and stick one piece to the solar cell...

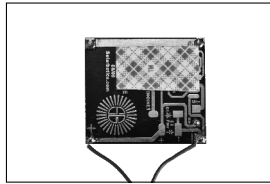

...and attach it to the motor as shown.

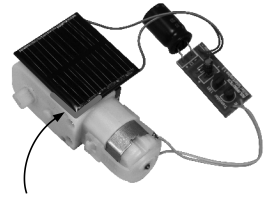

2.2

Take the remaining half of the double-sided tape and stick it to the bottom of the Solar Engine circuit board.

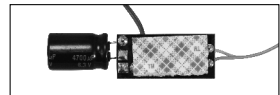

2.3

Mount the assembly into the slot on the base plate of the Marble Machine. Peel the tape and stick the Solar Engine to the base plate, making sure to align it like shown. Arc the motor wire (see photo), so it stays clear of the bottom rail when assembled.

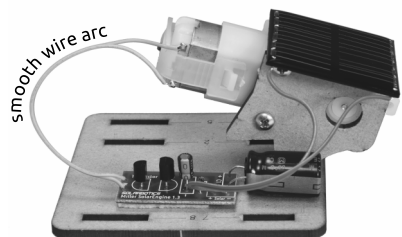

3. Gluing the Rails

Glue takes time to cure, so let's start with the spiral assembly. Glue the diamond to it's shadow marked on the spiral. For the bottom rail assembly, glue the narrow "U" to the larger "U". Finally, for the top rail assembly, glue the thin sliver to the thicker one.

Spiral rail

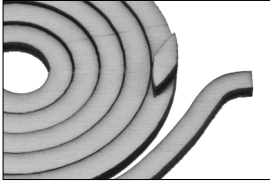

Bottom rail

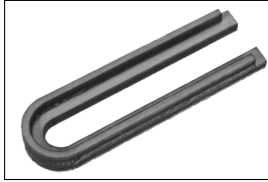

Top rail

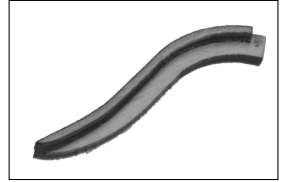

4. Drive Gear Assembly

Pop out the drive gear pieces from the wooden carrier board and assemble them in the order shown. Glue is not necessary (but optional).

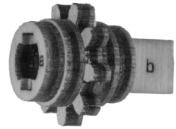
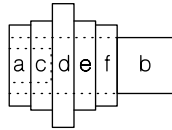

5. Gear Wheel Assembly

Follow the diagram and stack the pieces together onto the axle. Again, gluing them together is optional for this step.

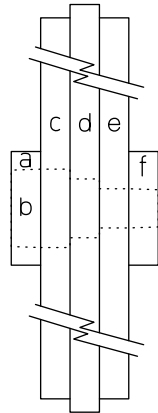

⚠ The holes do not line up vertically! They stagger, to help roll the ball out at the top of the track.

This text will face away from the spiral ramp during final assembly. The hubs are sized so it fits into the final assembly only one way.

VIDEO RESOURCES

The Solar Marble Machine in action: srbtcs.co/slrMarble

The Solar Marble Machine home page for updates and tips: srbtcs.co/KMMMS

The Marble Machine Solar Engine assembly tutorial: srbtcs.co/marblEngine

The Marble Machine wooden frame assembly tutorial: srbtcs.co/marblFrame

Tips on soldering: srbtcs.co/solderVid2

The Solar Engine is also used in other Solarbotics kits: srbtcs.co/MSEkits

Solar Engine datasheet: srbtcs.co/solrEngine

6. Final Assembly (see next page for diagram)

To put it all together, refer to the exploded Marble Machine diagram below, and follow these steps:

- 1. Push the inner wheel frame into the base plate.** The motor should fit snugly against the frame, with the motor shaft in the center of crank shaft hole.
- 2. Slide the gear wheel assembly into the inner wheel frame.** The text on the wheel assembly should face outwards, away from the frame.
- 3. Push the gear assembly onto the motor shaft,** so that it sits flush against the inner wheel frame. The wheel assembly gears and motor gear should mesh nicely.
- 4. Push the outer wheel frame into the base plate.** Both the gear and wheel assemblies should sit inside their respective holes. Make sure that the wheel frame is flush against the wheel assembly.
- 5. Slide the crank handle spacer and caps** onto the shaft of the gear assembly. Glue is optional.

6. Attach the spiral frame by pushing it into the base plate. Glue is optional.

7. Secure the spiral rail to the frame. Start at the top, then push the spiral downwards. While pushing, slide the spiral back & forth to lock the rail under each notch. Glue the top end of the spiral rail to the inner frame.

8. Install the return ramp between the spiral holder and inner wheel frame. Make sure the motor wires are not obstructing the return path of the marbles! Glue is optional, but recommended.

9. Wedge the top rail into the inner wheel frame. Glue it to the diamond support on the top spiral arm and the ball exit notch.

Load the marbles and manually crank them in, while watching for any sticky motion. Make sure all frame pieces are well seated on the base for proper alignment.

In sunlight, the motor pulses every few seconds, and a ball will drop about every minute. In indoor light, the motor slows to a pulse every few minutes (be patient)!

FINAL ASSEMBLY DIAGRAM

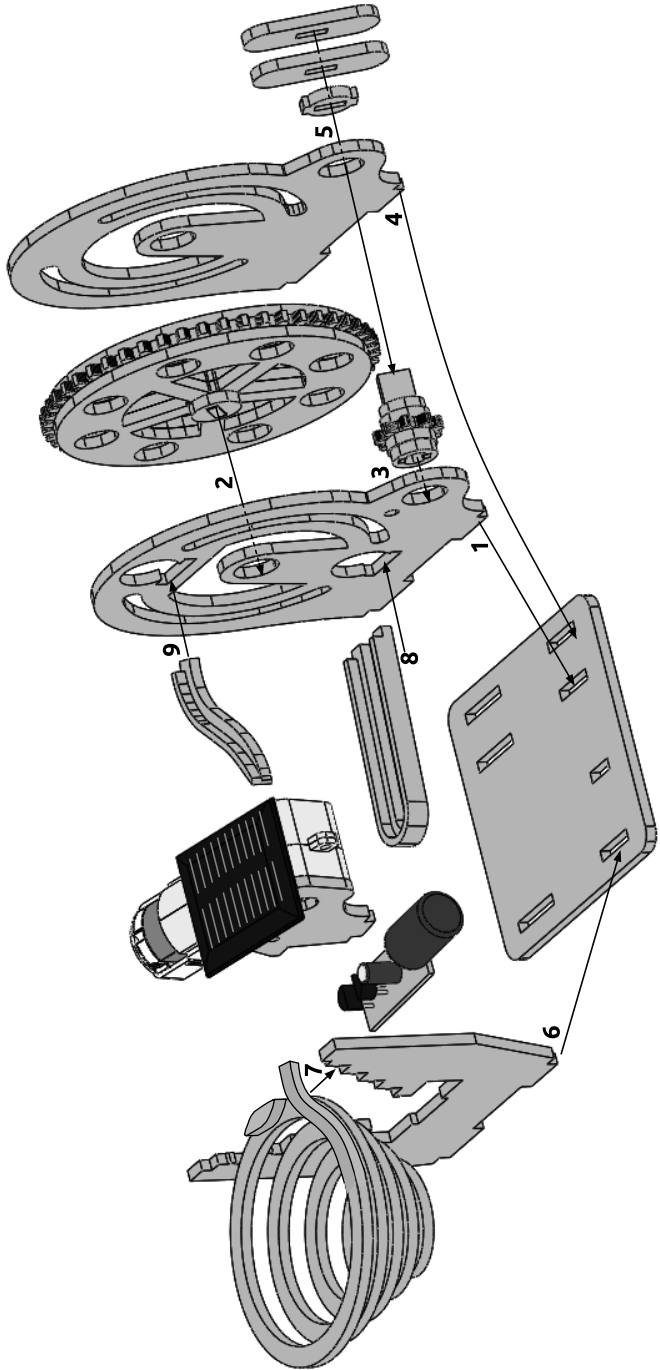

Solar Marble Machine Kit

TROUBLESHOOTING

If your Marble Machine isn't fully functional, check this troubleshooting list:

The marble doesn't consistently run the entire length of the spiral: Find the ledge where the marble jumps off and shift the spiral forwards or backwards slightly to make that section of ledge a bit larger. Also make sure the surface that the machine is sitting on is completely even and horizontal.

The motor is not moving: Make sure your circuit is soldered correctly. Most errors are fixed by re-soldering. Check the orientation of all polarity-sensitive components and their location on the circuit. Look for broken wire connections.

The wheel assembly gets stuck while turning: Use some sandpaper wrapped around a pencil and sand the shaft holes of the two inner wheel frames. This will reduce the friction on the wheel assembly shaft, making it spin easier. Check to see if any glue from the top rail has dropped into the inner wheel frame and gummed up the works.

Solar engine not working: see step 1.6.

SOLARBOTICS "NO FEAR" WARRANTY

If damage occurs during construction, [contact us](#). We'll make sure you get the replacement parts to have a successful Marble Machine experience!

Visit us online for more info and cool stuff:

www.solarbotics.com

**Questions or
comments?
Let us know!**

✉ support@solarbotics.com
☎ 1-866-276-2687 (TOLL FREE)
MON-FRI, 9AM- 5PM MST

3740D - 11A Street NE
Suite 101
Calgary, Alberta T2E 6M6
Canada



This work is licensed under a Creative Commons Attribution-ShareAlike 3.0 Unported License.

🇨🇦 Made in Canada



Solarbotics Ltd. is not responsible for any special, incidental, or consequential damages resulting from any breach of warranty, or under any legal theory, including lost profits, downtime, good-will, damage to or replacement of equipment or property, and any costs or recovering of any material or goods associated with the assembly or use of this product. Solarbotics Ltd. reserves the right to make substitutions and changes to this product without prior notice. Keep out of reach of children. Product contains small parts, even when assembled, that might be a choking hazard for children under five. © 2014 Solarbotics Ltd. All rights reserved. Parts, quantities, features and specifications are subject to change without notice. All other trademarks are property of their respective owners. "SOLARBOTICS" is a trademark of Solarbotics Ltd. Reg. CIPO / USPTO.